

Dell™ 7700FullHD Projector

User's Guide

Notes, Cautions, and Warnings



NOTE: A NOTE indicates important information that helps you make better use of your computer.



CAUTION: A CAUTION indicates potential damage to hardware or loss of data if instructions are not followed.



WARNING: A WARNING indicates a potential for property damage, personal injury, or death.

Information in this document is subject to change without notice.

© 2012 Dell Inc. All rights reserved.

Reproduction of these materials in any manner whatsoever without the written permission of Dell Inc. is strictly forbidden.

Trademarks used in this text: *Dell* and the *DELL* logo are trademarks of Dell Inc.; *DLP* and *DLP* logo are trademarks of TEXAS INSTRUMENTS INCORPORATED; *Microsoft* and *Windows* are either trademarks or registered trademarks of Microsoft Corporation in the United States and/or other countries.

Other trademarks and trade names may be used in this document to refer to either the entities claiming the marks and names or their products. Dell Inc. disclaims any proprietary interest in trademarks and trade names other than its own.

Model 7700FullHD

March 2012 Rev. A00

Contents

1	Your Dell Projector	7
	About Your Projector	8
2	Connecting Your Projector	10
	Installing the Optional Wireless Dongle	11
	Connecting to a Computer	12
	Connecting a Computer Using a VGA Cable	12
	Monitor Loop-Through Connection Using VGA Cables	13
	Connecting a Computer Using a RS232 Cable	14
	Connecting a Computer by USB Cable	15
	Connecting a Computer Using Wireless Dongle (Optional)	16
	Connecting a DVD Player	17
	Connecting a DVD Player Using an S-Video Cable	17
	Connecting a DVD Player Using a Composite Video Cable	18
	Connecting a DVD Player Using a Component Video Cable	19
	Connecting a DVD Player Using a 3 RCA Component Video Cable	20
	Connecting a DVD Player Using an HDMI Cable	21
	Connecting to Local Area Network	22
	To project an image and control the projector that is connected to a network through a RJ45 cable.	22

Professional Installation Options: Installation for Driving Automatic Screen	23
Connection With Commercial RS232 Control Box	24
3 Using Your Projector	25
Turning Your Projector On	25
Turning Your Projector Off	25
Adjusting the Projected Image	26
Raising the Projector Height	26
Lowering the Projector Height	26
Adjusting the Projector Zoom and Focus	27
Adjusting Projection Image Size	28
Using the Control Panel	30
Using the Remote Control	32
Installing the Remote Control Batteries	35
Operating Range With Remote Control	36
Using the On-Screen Display	37
INPUT SOURCE	37
AUTO ADJUST	38
BRIGHTNESS/CONTRAST	39
VIDEO MODE	39
VOLUME	40
AUDIO INPUT	40
ADVANCED SETTINGS	40
LANGUAGE	54
HELP	54

Wireless Networking Installation	55
Enable Wireless on the Projector	56
Install the Wireless Application Software on Your Computer	58
Launch the Wireless Application	61
Presentation to Go (PtG) Installation	65
PtG Viewer	66
Photo Viewer	66
PtG/Photo Function Introduction	67
PtG Overview	67
Photo Overview	68
Buttons-Introduction	68
Install the PtG Converter Application Software on Your Computer	69
Using the PtG Converter	70
Audio Projection Installation	71
Enable Wireless or LAN on the Projector	72
Install the Wireless Application Software on Your Computer	73
Launch the Wireless Application	74
Login	75
Video Stream Installation	76
Video Stream Support Format	76
Enable Wireless or LAN on the Projector	77
Install the Wireless Application Software on Your Computer	77
Launch the Wireless Application	77
Login	77
Managing the Projector From Web Management	78
Configuring the Network Setting	78

Accessing Web Management	78
Make Application Token	99
4 Troubleshooting Your Projector	101
Guiding Signals	105
Changing the Lamp	106
5 Specifications	108
6 Contacting Dell	115
7 Appendix: Glossary	116

Your Dell Projector

Your projector comes with all the items shown below. Ensure that you have all the items, and contact Dell™ if anything is missing.

Package Contents

Power cable

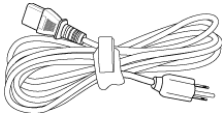

1.8 m VGA cable (VGA to VGA)

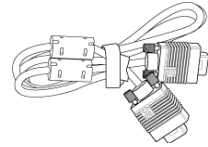

1.8 m USB cable (USB-A to USB-B)

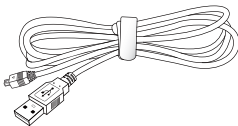

Remote control



CD User's Guide and Documentation

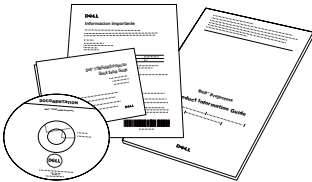

AAA Batteries (2)



About Your Projector

Top View

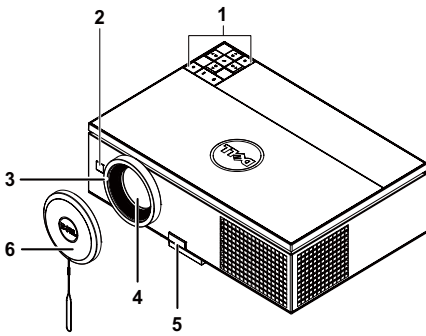

Bottom View

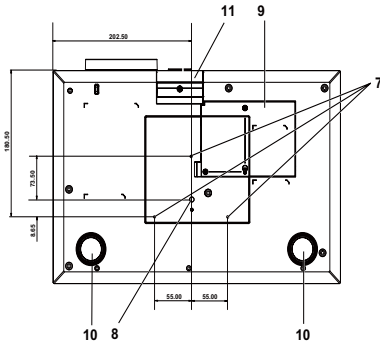

1	Control panel
2	IR receivers
3	Focus ring
4	Lens
5	Elevator button for height adjustments
6	Lens cap
7	Mounting holes for ceiling mount: Screw hole M3 x 6.5 mm depth. Recommended torque <8 kgf-cm
8	Mounting hole for tripod: Insert nut 1/4" * 20 UNC
9	Lamp cover
10	Tilt adjustment wheel
11	Elevator foot

CAUTION: Safety Instructions

- 1 Do not use the projector near appliances that generate a lot of heat.
- 2 Do not use the projector in areas where there is an excessive amount of dust. The dust may cause the system to fail and the projector will automatically shut down.
- 3 Ensure that the projector is mounted in a well-ventilated area.
- 4 Do not block the ventilation slots and openings on the projector.
- 5 Ensure the projector operates between ambient temperatures (5 °C to 35 °C).

- 6** Do not try to touch the ventilation outlet as it can become very hot after the projector has been turned on or immediately after it is turned off.
- 7** Do not look into the lens while the projector is on as it may cause injury to your eyes.
- 8** Do not place any objects near or in front of the projector or cover its lens while the projector is on as the heat may cause the object to melt or burn.
- 9** Do not use the wireless projector near cardiac pacemakers.
- 10** Do not use the wireless projector near medical equipment.
- 11** Do not use the wireless projector near microwave ovens.

**NOTE:**

- Do not attempt to ceiling mount the projector yourself. It should be installed by a qualified technician.
- Recommended Projector Ceiling Mount Kit (P/N: C3505). For more information, see the Dell Support website at support.dell.com.
- For more information, see the *Safety Information* that shipped with your projector.
- The 7700FullHD projector can only be used indoors.

2

Connecting Your Projector

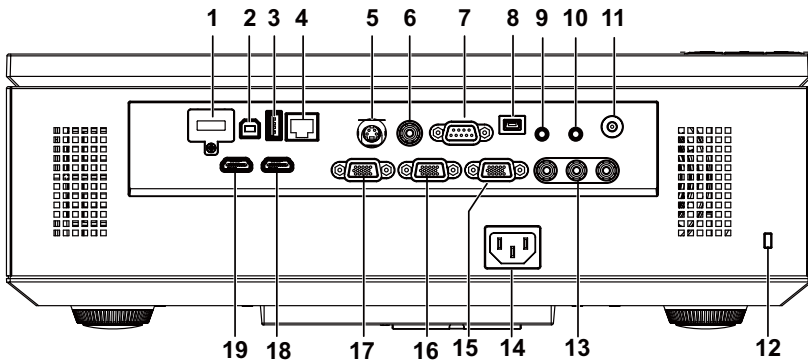

1	WiFi USB (Type A) connector	11	+12 V DC out connector
2	USB Type B connector for USB Display	12	Security cable slot
3	USB Type A connector for USB Viewer	13	Component Video input connector
4	RJ45 connector	14	Power cord connector
5	S-Video connector	15	VGA-A output (monitor loop-through) connector
6	Composite Video connector	16	VGA-B input (D-sub) connector
7	RS232 (D-sub) connector	17	VGA-A input (D-sub) connector
8	Mini USB (Mini Type B) connector for remote control	18	HDMI-B connector
9	Audio output connector	19	HDMI-A connector
10	Audio input connector		

CAUTION: Before you begin any of the procedures in this section, follow the Safety Instructions as described on page 8.

Installing the Optional Wireless Dongle

Your projector must be installed with a wireless dongle if you want to use the wireless networking option. Refer to "Wireless Networking Installation" on page 55. The wireless dongle is not shipped with your projector. You can purchase it on the Dell website at www.dell.com.

- 1 Unscrew and take off the wireless cover.

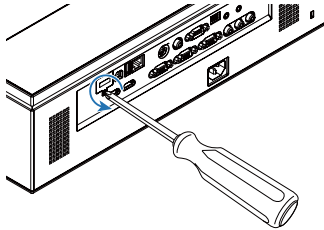

- 2 Plug in the wireless dongle.

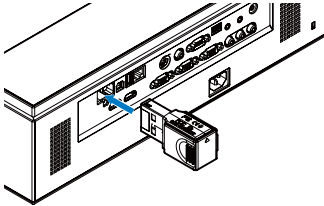

- 3 Assemble the wireless cover.

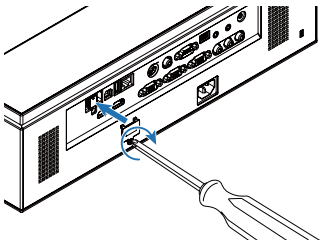

Connecting to a Computer

Connecting a Computer Using a VGA Cable

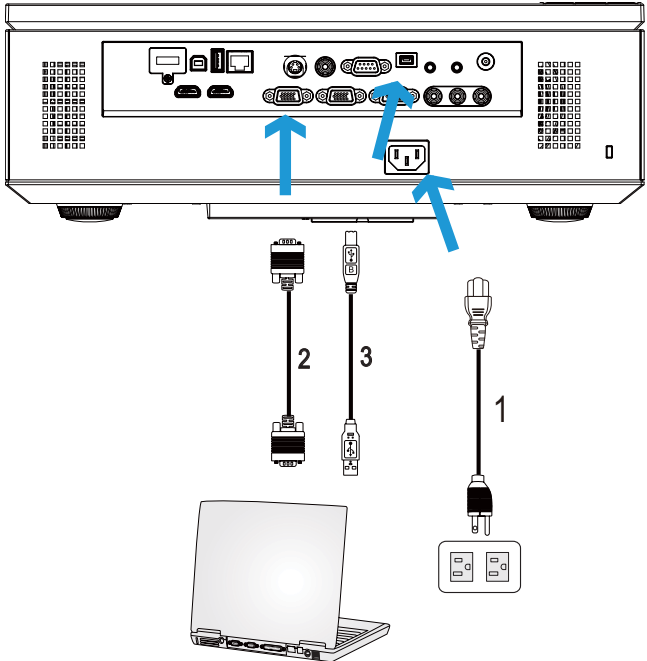

1	Power cord
2	VGA to VGA cable
3	USB-A to Mini USB-B cable

NOTE: The Mini USB cable must be connected if you want to use the Page Up and Page Down features on the remote control.

NOTE: The Mini USB cable is not shipped with your projector. You can purchase the Mini USB cable on the Dell website at www.dell.com.

Monitor Loop-Through Connection Using VGA Cables

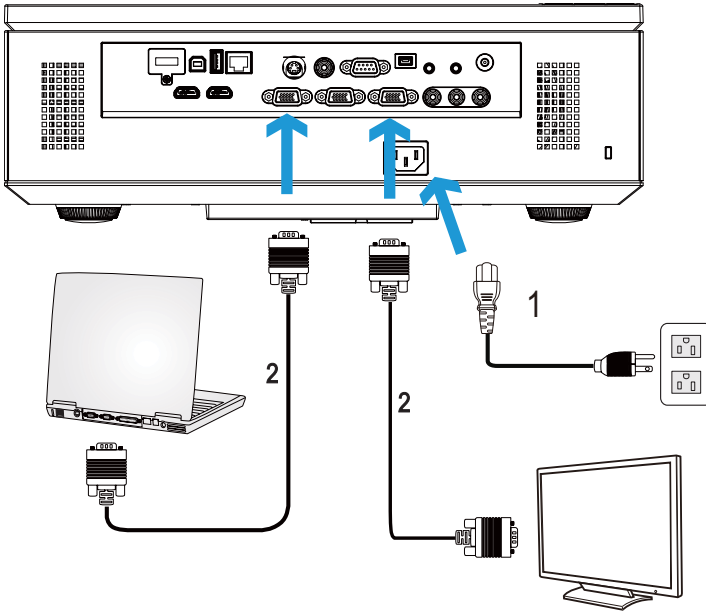

1	Power cord
2	VGA to VGA cable



NOTE: Only one VGA cable is shipped with your projector. An additional VGA cable can be purchased on the Dell website at www.dell.com.

Connecting a Computer Using a RS232 Cable

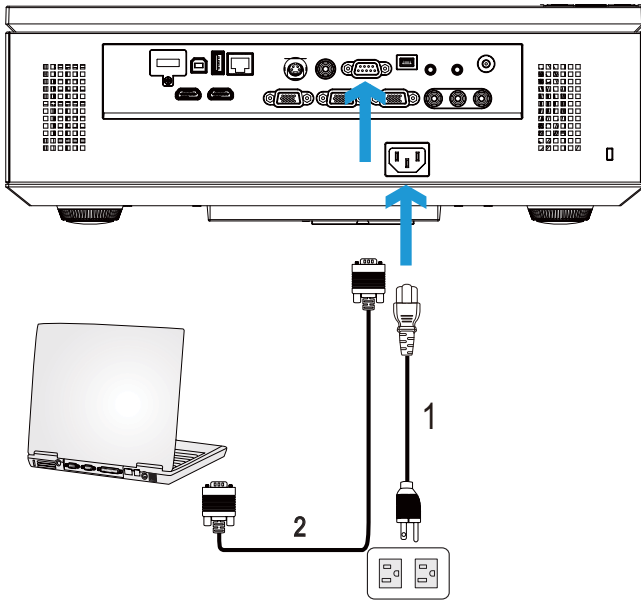

1	Power cord
2	RS232 (9-pin D-sub female to female pin2-3 swap) cable

NOTE: The RS232 (9-pin D-sub female to female pin2-3 swap) cable is not shipped with your projector. Consult a professional installer for the cable and RS232 remote control software.

Connecting a Computer by USB Cable

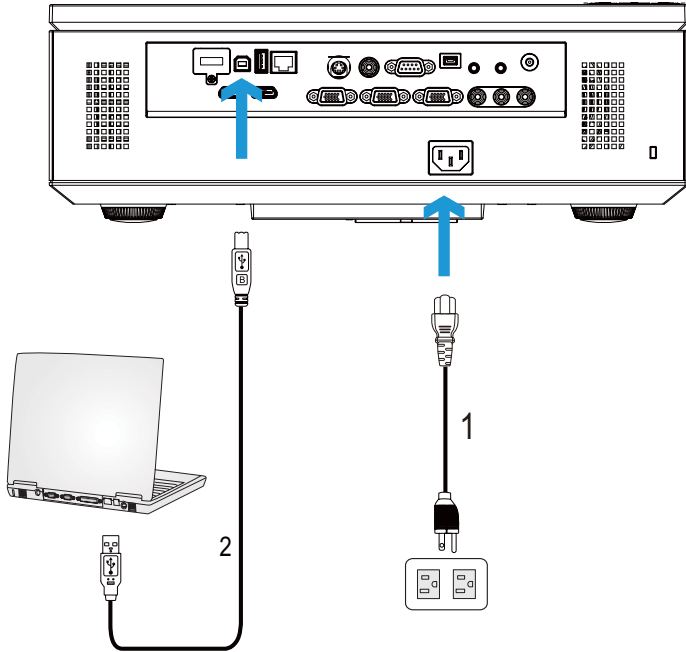



1	Power cord
2	USB-A to USB-B cable

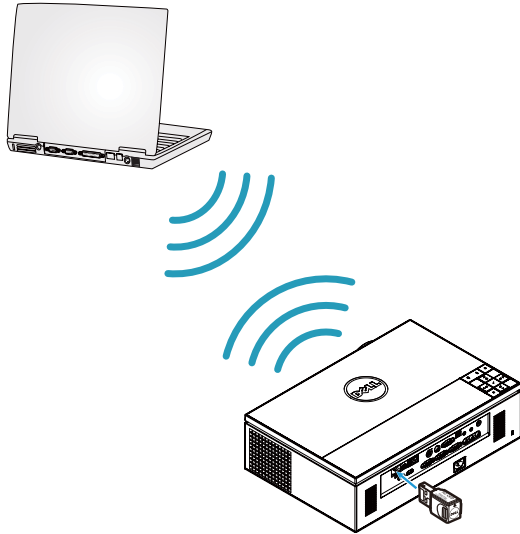

NOTE: Plug and Play. Only one USB cable is shipped with your projector. An additional USB cable can be purchased on the Dell website at www.dell.com.

Connecting a Computer Using Wireless Dongle (Optional)



-  **NOTE:** Your computer should be equipped with a wireless connector and properly configured to detect another wireless connection. Refer to your computer's documentation on how to configure a wireless connection.
-  **NOTE:** Your projector must be installed with a wireless dongle if you want to use the wireless networking. Refer to "Wireless Networking Installation" on page 55.

Connecting a DVD Player

Connecting a DVD Player Using an S-Video Cable

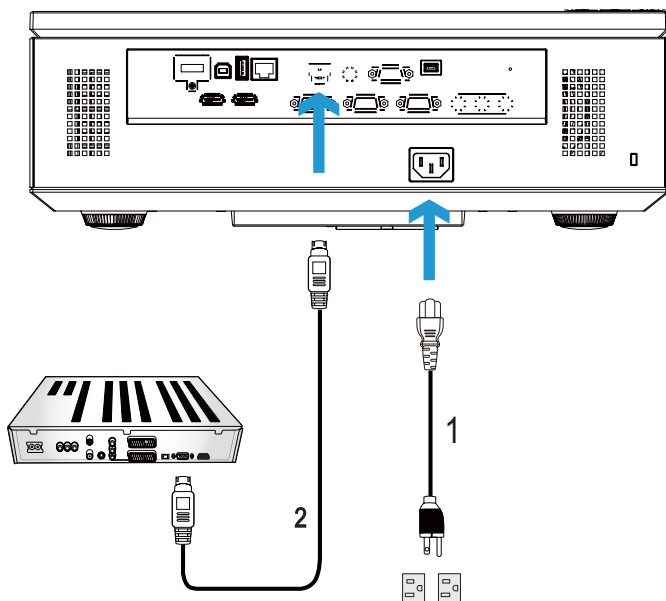

1	Power cord
2	S-Video cable



NOTE: The S-Video cable is not shipped with your projector. You can purchase the S-Video extension (50 ft/100 ft) cable on the Dell website at www.dell.com.

Connecting a DVD Player Using a Composite Video Cable

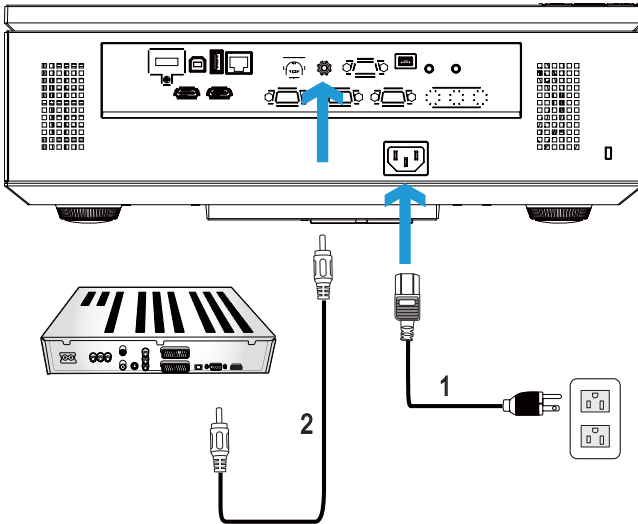

1	Power cord
2	Composite Video cable



NOTE: The Composite Video cable is not shipped with your projector. You can purchase the Composite Video Extension (50 ft/100 ft) cable on the Dell website at www.dell.com.

Connecting a DVD Player Using a Component Video Cable

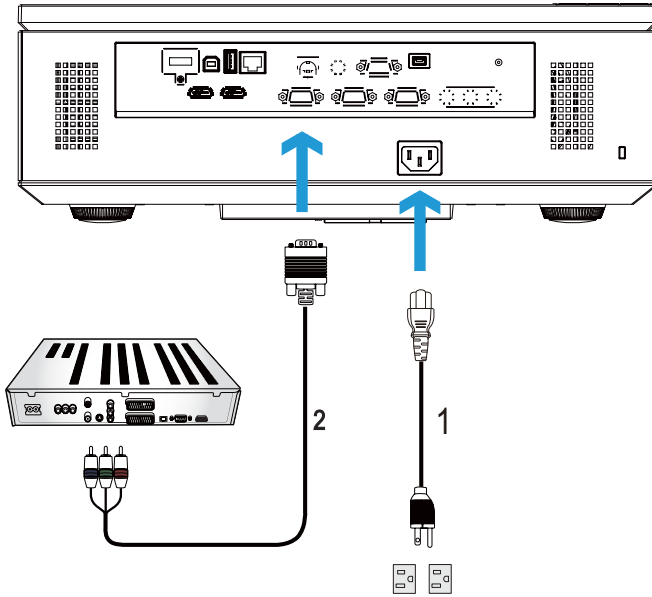

1	Power cord
2	VGA to Component Video cable



NOTE: The VGA to Component Video cable is not shipped with your projector. You can purchase the VGA to Component Video Extension (50 ft/100 ft) cable on the Dell website at www.dell.com.

Connecting a DVD Player Using a 3 RCA Component Video Cable

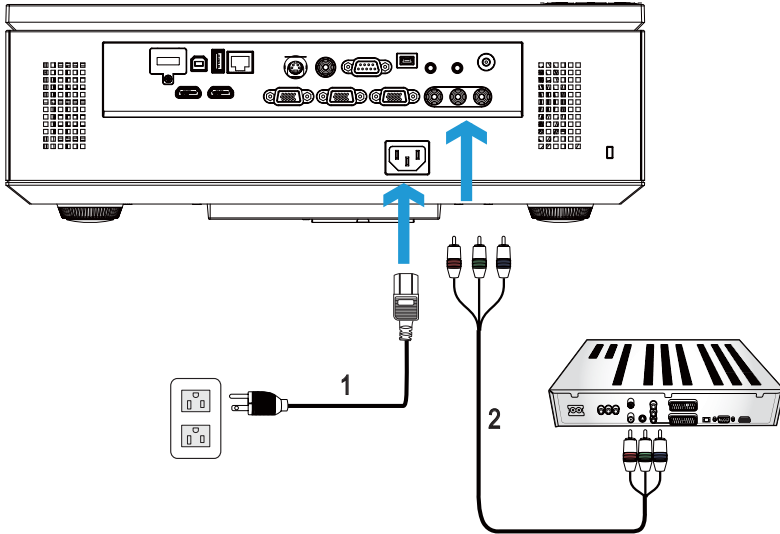

1	Power cord
2	3 RCA to 3 RCA Component Video (Male to Male) cable



NOTE: The 3 RCA to 3 RCA Component Video (Male to Male) cable is not shipped with your projector. You can purchase the 3 RCA to 3 RCA Component Video (Male to Male) cable Extension (50 ft/100 ft) cable on the Dell website at www.dell.com.

Connecting a DVD Player Using an HDMI Cable

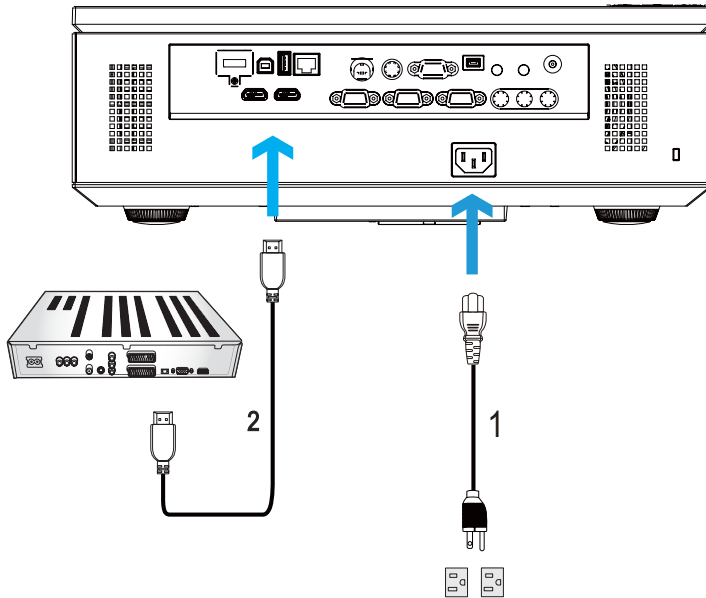

1	Power cord
2	HDMI cable



NOTE: The HDMI cable is not shipped with your projector. You can purchase the HDMI cable on the Dell website at www.dell.com.

Connecting to Local Area Network

To project an image and control the projector that is connected to a network through a RJ45 cable.

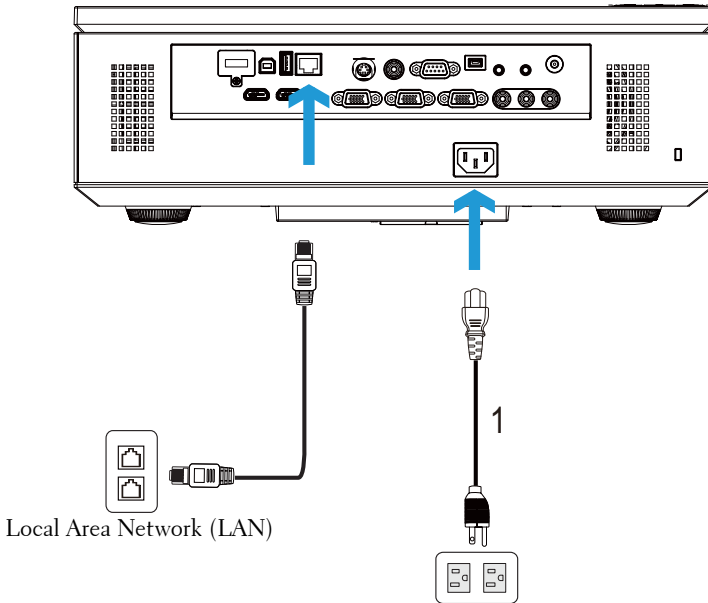

Local Area Network (LAN)

1	Power cord
2	RJ45 cable



NOTE: The RJ45 cable is not shipped with your projector. You can purchase the RJ45 cable on the Dell website at www.dell.com.

Professional Installation Options: Installation for Driving Automatic Screen

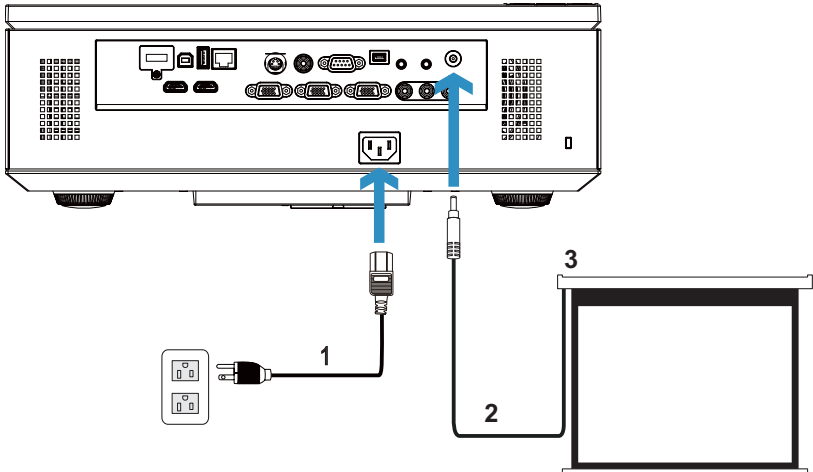

1	Power cord
2	12 V DC Plug
3	Motorized projection screen

 **NOTE:** Use a 12 V DC plug in, 1.7 mm (ID) x 4.00 mm (OD) x 9.5 mm (shaft), to connect the automatic screen to the projector.

12 V DC Plug



Connection With Commercial RS232 Control Box

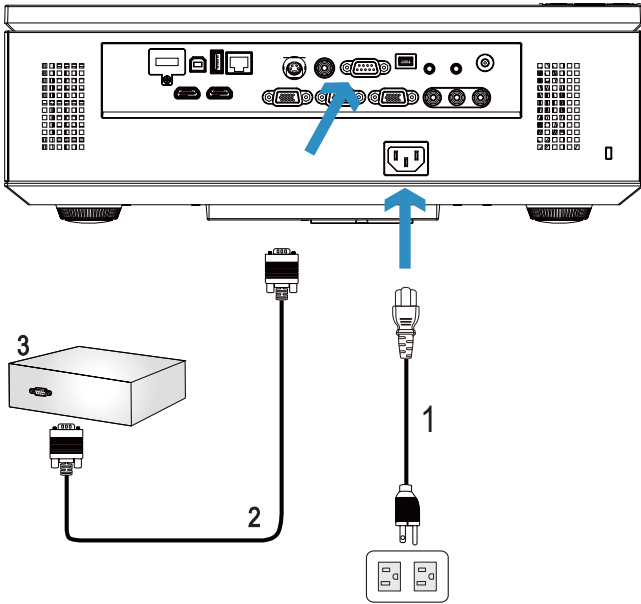

1	Power cord
2	RS232 (9-pin D-sub female to female pin2-3 swap) cable
3	Commercial RS232 control box



NOTE: The RS232 (9-pin D-sub female to female pin2-3 swap) cable is not shipped with your projector. Consult a professional technician to obtain the cable.

Using Your Projector

Turning Your Projector On

 **NOTE:** Turn on the projector before you turn on the source (computer, DVD player, etc.). The **Power** button light blinks blue until pressed.

- 1 Remove the lens cap.
- 2 Connect the power cord and appropriate signal cables to the projector. For information about connecting the projector, see "Connecting Your Projector" on page 10.
- 3 Press the **Power** button (see "Using the Control Panel" on page 30 to locate the **Power** button).
- 4 Turn on your source (computer, DVD player, etc.)
- 5 Connect your source to the projector using the appropriate cable. See "Connecting Your Projector" on page 10 for instructions to connect your source to the projector.
- 6 By default, the input source of the projector is set to VGA-A. Change the input source of the projector if necessary.
- 7 If you have multiple sources connected to the projector, press the **Source** button on the remote control or control panel to select the desired source. See "Using the Control Panel" on page 30 and "Using the Remote Control" on page 32 to locate the **Source** button.

Turning Your Projector Off

 **CAUTION:** Unplug the projector after properly shutting down as explained in the following procedure.

- 1 Press the **Power** button. Follow the instruction displayed on screen to properly turn off the projector.

 **NOTE:** The "**Press Power Button to Turn off Projector**" message will appear on the screen. The message disappears after 5 seconds or you can press the **Menu** button to clear it.

- 2 Press the **Power** button again. The cooling fans continue to operate for 120 seconds.

3 To power off the projector quickly, press the Power button and hold for 1 second while the projector's cooling fans are still running.

NOTE: Before you turn on the projector again, wait for 60 seconds to allow the internal temperature to stabilize.

4 Disconnect the power cord from the electrical outlet and the projector.

Adjusting the Projected Image

Raising the Projector Height

- 1 Press the Elevator button.
- 2 Raise the projector to the desired display angle, and then release the button to lock the elevator foot into position.
- 3 Use the tilt adjustment wheel to fine-tune the display angle.

Lowering the Projector Height

- 1 Press the Elevator button.
- 2 Lower the projector, then release the button to lock the elevator foot into position.

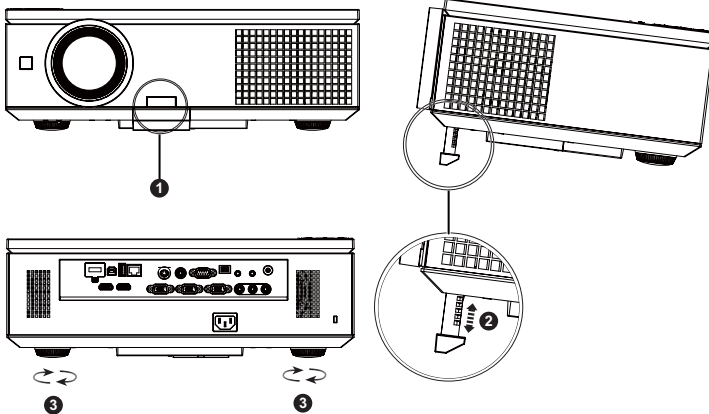

1	Elevator button
2	Elevator foot (Angle of tilt: 0 to 8 degrees)
3	Tilt adjustment wheel

Adjusting the Projector Zoom and Focus

CAUTION: To avoid damaging the projector, ensure that the side door is fully closed and the elevator foot is fully retracted before moving the projector.

- 1 Open the side door of the projector.
- 2 Unlock the lens shift lock, before you adjust the lens shift.
- 3 Turn the vertical/horizontal lens shift knob to shift the lens.
- 4 After adjusting the lens shift, lock the lens shift lock.
- 5 Pull the zoom ring adjustment up and down to zoom in and out.
- 6 Rotate the focus ring until the image is clear. THE projector focuses at distances ranging between 3.28 ft to 39.37 ft (1.0 m to 12.0 m).
- 7 Close the side door of the projector.

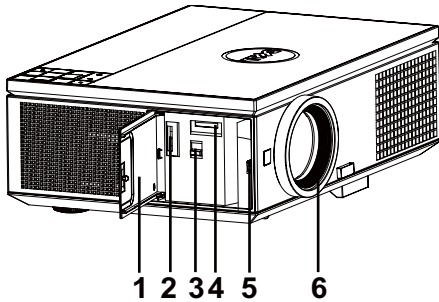

1	Side door
2	Vertical lens shift knob
3	Lens shift lock
4	Horizontal lens shift knob
5	Zoom ring
6	Focus ring

Adjusting Projection Image Size

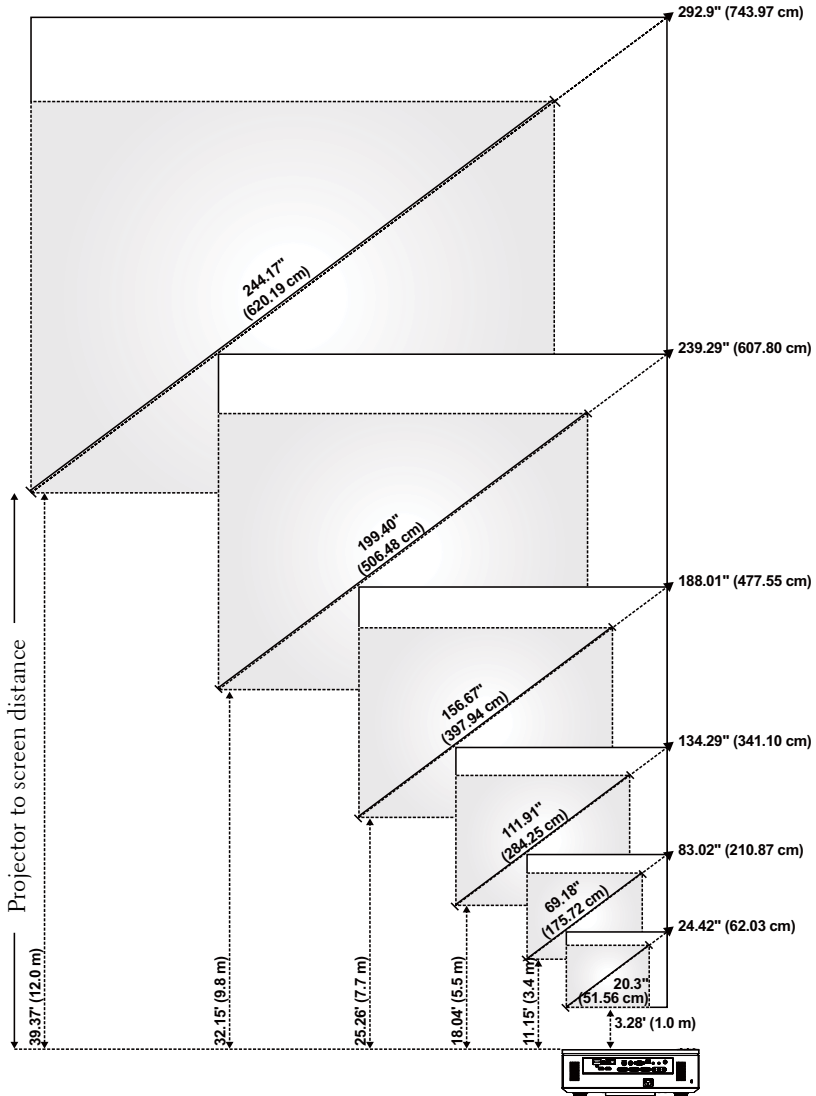



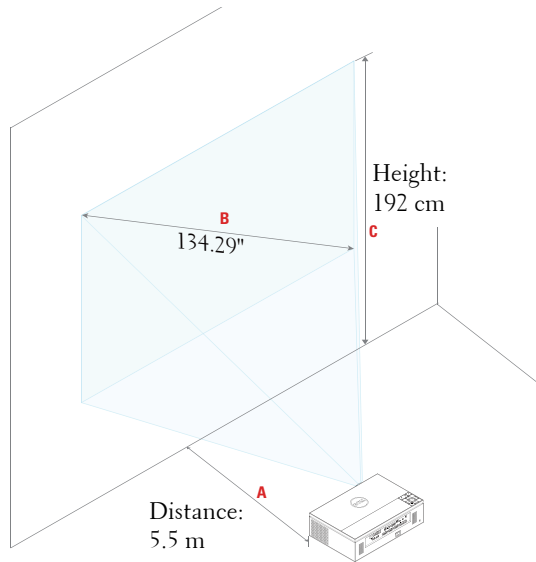



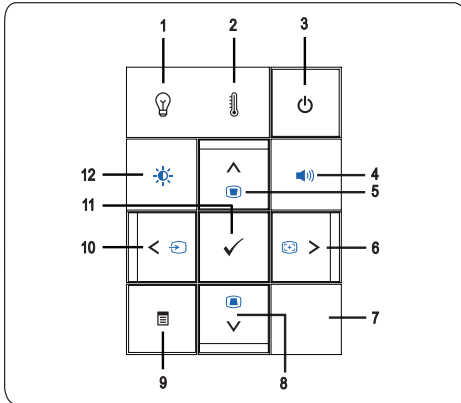









Desired Distance (m) <A>	(Min zoom)			(Max zoom)		
	Screen size		Top	Screen size		Top
	Diagonal (inch) 	W (cm) x H (cm)	From base to top of image (cm) <C>	Diagonal (inch) 	W (cm) x H (cm)	From base to top of image (cm) <C>
1	20.3	45 x 25	29	24.42	54 x 30	35
3.4	69.18	153 x 86	99	83.02	184 x 103	119
5.5	111.91	248 x 139	160	134.29	297 x 167	192
7.7	156.67	347 x 195	224	188.01	416 x 234	269
9.8	199.4	441 x 248	286	239.29	530 x 298	343
12	244.17	541 x 304	350	292.9	649 x 365	420



Using the Control Panel









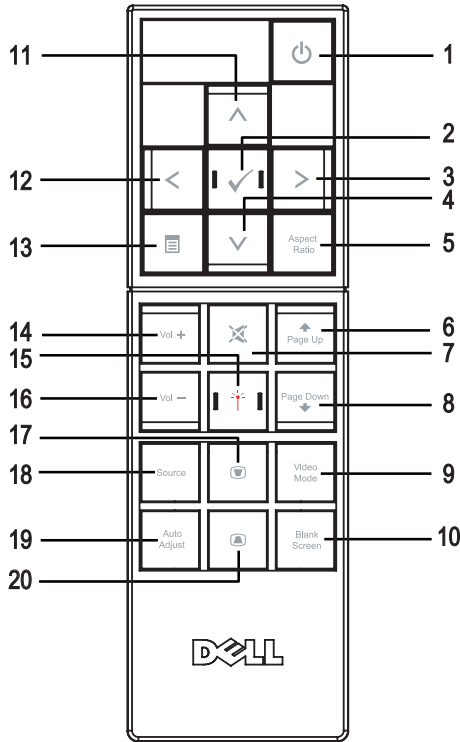









-
- 1 **LAMP warning light**  If the LAMP amber indicator is on or blinking, one of the following problems could be occurring:
- Lamp is reaching its end of usable life
 - Lamp module is not properly installed
 - Lamp driver failure
 - Color wheel failure
- For more information, see "Troubleshooting Your Projector" on page 101 and "Guiding Signals" on page 105.
-
- 2 **TEMP warning light**  If the TEMP amber indicator is on or blinking, one of the following problems could be occurring:
- Internal temperature of the projector is too high
 - Color wheel failure
- For more information, see "Troubleshooting Your Projector" on page 101 and "Guiding Signals" on page 105.
-
- 3 **Power**  Turns the projector on or off. For more information, see "Turning Your Projector On" on page 25 and "Turning Your Projector Off" on page 25.
-

4	Volume Control 	Allows you to increase or decrease the volume.
5	Up  / Keystone adjustment 	Press to navigate through the On-Screen Display (OSD) Menu items. Press to adjust image distortion caused by tilting the projector (+/-30 degrees).
6	Right  / Auto Adjust 	Press to navigate through the On-Screen Display (OSD) Menu items. Press to synchronize the projector to the input source.  NOTE: Auto Adjust does not operate if the on-screen display (OSD) is displayed.
7	IR Receiver	Point the remote control towards the IR receiver and press a button.
8	Down  / Keystone adjustment 	Press to navigate through the On-Screen Display (OSD) Menu items. Press to adjust image distortion caused by tilting the projector (+/-30 degrees).
9	Menu 	Press to activate the OSD. Use the directional keys and the Menu button to navigate through the OSD.
10	Left  / Source 	Press to navigate through the On-Screen Display (OSD) Menu items. Press to toggle through Analog RGB, Composite, Component (YPbPr via VGA), HDMI, and S-Video sources when multiple sources are connected to the projector.
11	Enter 	Press to confirm the selection item.
12	Brightness and Contrast Control 	Allows you to adjust the brightness and contrast values.

Using the Remote Control



1	Power 	Turns the projector on or off. For more information, see "Turning Your Projector On" on page 25 and "Turning Your Projector Off" on page 25.
2	Enter 	Press to confirm the selection.
3	Right 	Press to navigate through the On-Screen Display (OSD) Menu items.
4	Down 	Press to navigate through the On-Screen Display (OSD) Menu items.
5	Aspect Ratio	Press to change the aspect ratio of a displayed image.

6	Page up 	Press to move to the previous page.  NOTE: The Mini USB cable must be connected if you want to use the Page Up feature.
7	Mute 	Press to mute or un-mute the projector speaker.
8	Page down 	Press to move to the next page.  NOTE: The Mini USB cable must be connected if you want to use the Page Down feature.
9	Video mode	The projector has preset configurations that are optimized for displaying data (presentation slides) or video (movies, games, etc.). Press the Video Mode button to toggle between Presentation mode , Bright mode , Movie mode , sRGB , or Custom mode . Pressing the Video Mode button once will show the current display mode. Pressing the Video Mode button again will switch between modes.
10	Blank screen	Press to hide/unhide the image.
11	Up 	Press to navigate through the On-Screen Display (OSD) Menu items.
12	Left 	Press to navigate through the On-Screen Display (OSD) Menu items.
13	Menu 	Press to activate the OSD.
14	Volume up 	Press to increase the volume.
15	Laser	Point the remote control at the screen, press and hold the laser button to activate the laser light.  WARNING: Do not look at the laser point when it is active. Avoid directing the laser light on your eyes.
16	Volume down 	Press to decrease the volume.
17	Keystone adjustment 	Press to adjust image distortion caused by tilting the projector (+/-30 degrees).
18	Source	Press to switch between Analog RGB, Composite, Component (YPbPr, via VGA), HDMI, and S-Video source.

19	Auto Adjust	Press to synchronize the projector with the input source. Auto Adjust does not operate if the OSD is displayed.
20	Keystone adjustment	Press to adjust image distortion caused by tilting the projector (+/-30 degrees).



Installing the Remote Control Batteries

 **NOTE:** Remove the batteries from the remote control when not in use.

1 Press the tab to lift the battery compartment cover.

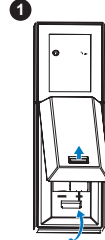

2 Check the polarity (+/-) marking on the batteries.

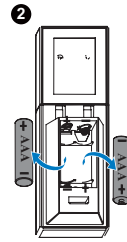

3 Insert the batteries and align their polarity correctly according to the marking in the battery compartment.

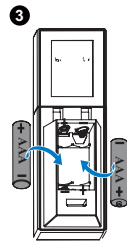

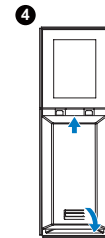

 **NOTE:** Avoid mixing different types of batteries or using new and old batteries together.

4 Slip the battery cover back.



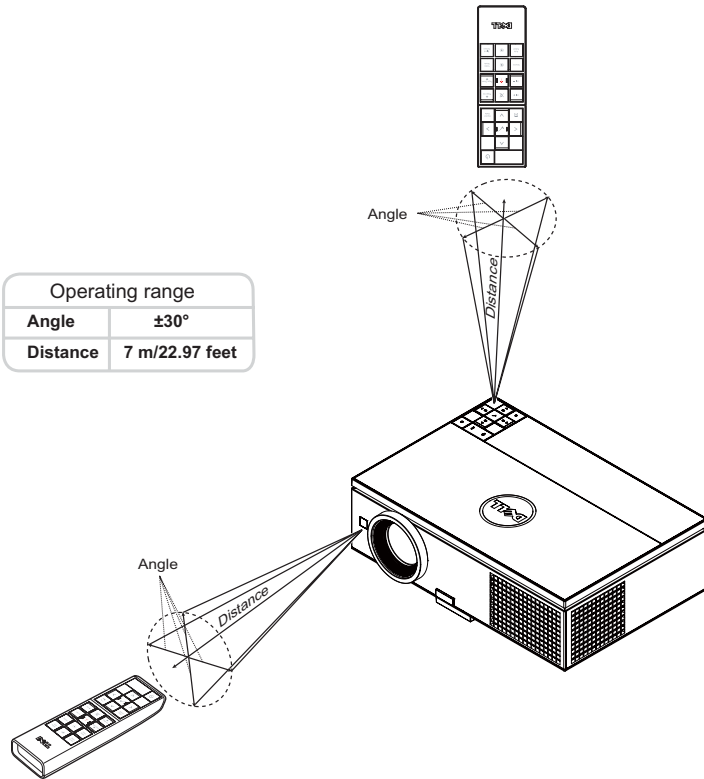







Operating Range With Remote Control



 **NOTE:** Actual operating range may slightly differ from the diagram. Weak batteries will also prevent the remote control from properly operating the projector.

Using the On-Screen Display

- The projector has a multi-language On-Screen Display (OSD) Menu that can be displayed with or without an input source.
- Press the Menu button on the control panel or the remote control to enter the Main Menu.
- To navigate through the tabs in the Main Menu, press the  or  buttons on your projector's control panel or remote control.
- To select a submenu, press the  or  button on your projector's control panel or remote control.
- To select an option, press the  or  buttons on your projector's control panel or remote control. When an item is selected, the color changes to dark blue.
- Use the  or  buttons on the control panel or remote control to adjust the settings.
- To go back to the Main Menu, press the  button on the control panel or the remote control.
- To exit the OSD, press the Menu button directly on the control panel or the remote control.

INPUT SOURCE

The Input Source menu allows you to select your projector's input source.

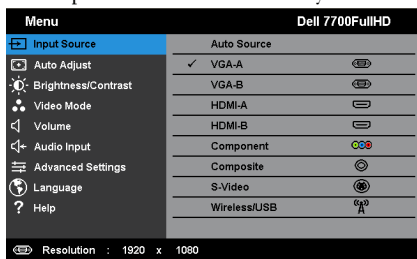

AUTO SOURCE—Press  to turn on or off Auto Source mode.

VGA-A—Press  to detect a VGA-A signal.

VGA-B—Press  to detect a VGA-B signal.

HDMI-A—Press  to detect a HDMI-A signal.

HDMI-B—Press  to detect a HDMI-B signal.

COMPONENT—Press  to detect a RCA Component signal.

COMPOSITE—Press  to detect a Composite Video signal.

S-VIDEO—Press  to detect a S-Video signal.

WIRELESS/USB—Press ✓ to activate the Input Source Wireless/USB menu.



NOTE: The Wireless/USB can be used after the "Wireless and LAN" option is turned on.

INPUT SOURCE WIRELESS/USB

The Input Source Wireless/USB menu allows you to activate the Wireless Display, USB Display, and USB Viewer.

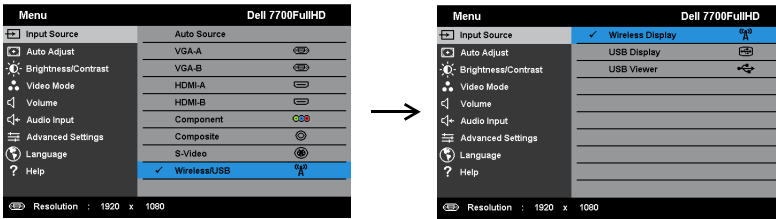

WIRELESS DISPLAY—Press ✓ to access the projector's Wireless Guide screen. See "Wireless Guide screen" on page 57.

USB DISPLAY—Allows you to display the computer/laptop screen to your projector via the USB cable.

USB VIEWER—Allows you to display photo and PPT files from your USB flash drive. See "Presentation to Go (PtG) Installation" on page 65.

AUTO ADJUST

Auto Adjust automatically adjusts the projector's Horizontal, Vertical, Frequency, and Tracking in PC mode.

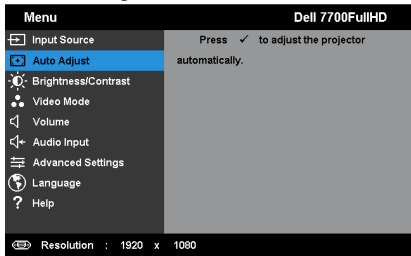

BRIGHTNESS/CONTRAST

The Brightness/Contrast menu allows you adjust the brightness/contrast settings of your projector.

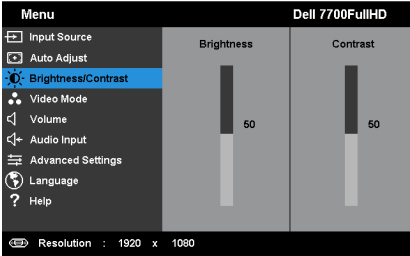

BRIGHTNESS—Use and to adjust the brightness of the image.

CONTRAST—Use and to adjust the display contrast.



NOTE: If you adjust the settings for **Brightness** and **Contrast** the projector automatically switch to **Custom mode**.

VIDEO MODE

The Video Mode menu allows you to optimize the display image: **Presentation**, **Bright**, **Movie**, **sRGB** (provides more accurate color representation), and **Custom** (set your preferred settings).

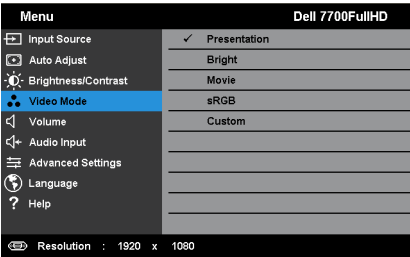

VOLUME

The Volume menu allows you adjust the volume settings of your projector.

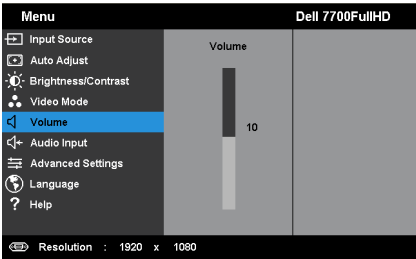

VOLUME—Press to increase the volume and to decrease the volume.

AUDIO INPUT

The Audio Input menu allows you to select your audio input source. The options are: **Analog In**, **HDMI-A**, **HDMI-B**, and **Wireless/LAN**.

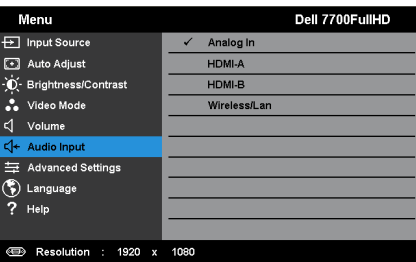

ADVANCED SETTINGS

The Advanced Settings menu allows you to change settings for **Image**, **Display**, **Projector**, **LAN**, **Wireless**, **Menu**, **Power**, **PIP**, and **Information**.

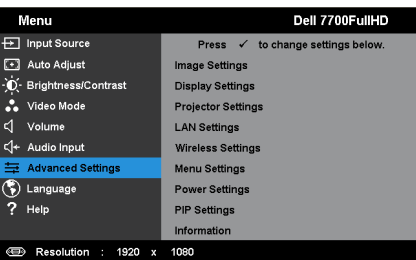

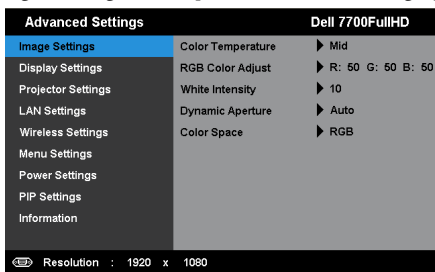

IMAGE SETTINGS (IN PC MODE)—Select and press  to activate image settings. The image settings menu provides the following options:



COLOR TEMPERATURE—Allows you to adjust the color temperature. The screen appears cooler at higher color temperatures and warmer at lower color temperatures. When you adjust the values in the **Color Adjust** menu, the Custom mode is activated. The values are saved in the Custom mode.

RGB COLOR ADJUST—Allows you to manually adjust the colors red, green, and blue.

WHITE INTENSITY—Press  and use  and  to display white intensity.

DYNAMIC APERTURE—Allows you to set the projector dynamic aperture. The options are: Off, Dynamic, and Auto.

COLOR SPACE—Allows you to select the color space. The options are: RGB, YCbCr, and YPbPr.



NOTE: If you adjust the settings for **Color Temperature**, **RGB Color Adjust**, and **White Intensity** the projector automatically switch to **Custom mode**.

IMAGE SETTINGS (IN VIDEO MODE)—Select and press  to activate image settings. The image settings menu provides the following options:

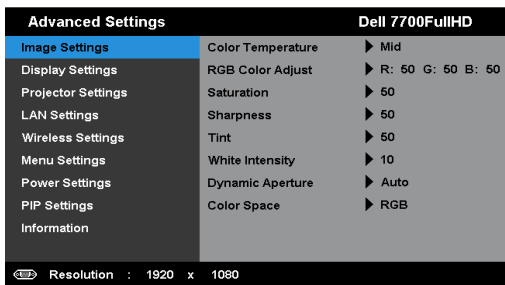

COLOR TEMPERATURE—Allows you to adjust the color temperature. The screen appears cooler at higher color temperatures and warmer at lower color temperatures. When you adjust the values in the **Color Adjust** menu, the Custom mode is activated. The values are saved in the Custom mode.

RGB COLOR ADJUST—Allows you to manually adjust the colors red, green, and blue.

SATURATION—Allows you to adjust the video source from black and white to fully saturated color. Press to increase the amount of color in the image and to decrease the amount of color in the image.

SHARPNESS—Press to increase the sharpness and to decrease the sharpness.

TINT—Press to increase the amount of green in the image and to decrease the amount of green in the image (available for NTSC only).

WHITE INTENSITY—Press and use and to display white intensity.

DYNAMIC APERTURE—Allows you to set the projector dynamic aperture. The options are: **Off**, **Dynamic**, and **Auto**.

COLOR SPACE—Allows you to select the color space. The options are: RGB, YCbCr, and YPbPr.



NOTE:

- 1 If you adjust the settings for **Color Temperature**, **RGB Color Adjust**, **Saturation**, **Sharpness**, **Tint**, and **White Intensity** the projector automatically switch to **Custom mode**.
- 2 **Saturation**, **Sharpness**, and **Tint** are only available when the input source is from Component, Composite, or S-Video.

DISPLAY SETTINGS (IN PC MODE)—Select and press ✓ to activate display settings. The display settings menu provides the following options:

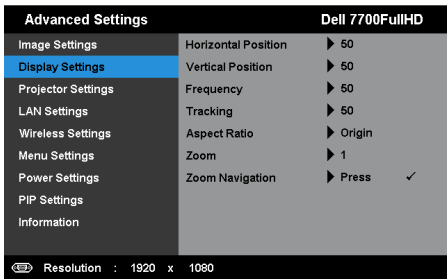

HORIZONTAL POSITION—Press to move the image right and to move the image left.

VERTICAL POSITION—Press to move the image up and to move the image down.

FREQUENCY—Allows you to change the display data clock frequency to match the frequency of your computer’s graphics card. If you see a vertical flickering wave, use the Frequency control to minimize the bars. This is a coarse adjustment.

TRACKING—Synchronize the phase of the display signal with the graphic card. If you experience an unstable or flickering image, use Tracking to correct it. This is a fine adjustment.

ASPECT RATIO—Allows you to select the aspect ratio to adjust how the image appears. Options are: Origin, 16:9, and 4:3.

- Origin — Select Origin to maintain the aspect ratio of the image projector according to the input source.
- 16:9 — The input source scales to fit the width of the screen to project a 16:9 screen image.
- 4:3 — The input source scales to fit the screen and projects a 4:3 image.

Zoom—Press and to zoom and view the image.

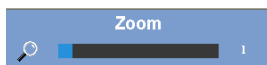

Adjust the image scale by pressing or and press ✓ to view on your remote control only.



Zoom Navigation—Press ✓ to activate the Zoom Navigation menu.

Use to navigate the projection screen.

DISPLAY SETTINGS (IN VIDEO MODE)—Select and press ✓ to activate display settings. The display settings menu provides the following options:

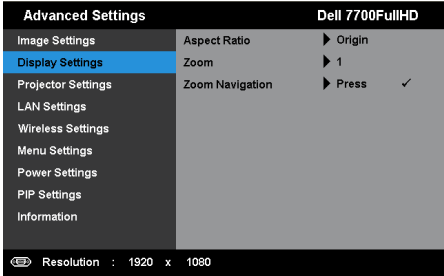

ASPECT RATIO—Allows you to select the aspect ratio to adjust how the image appears. Options are: Origin, 16:9, and 4:3.

- Origin — Select Origin to maintain the aspect ratio of image projector according to the input source.
- 16:9 — The input source scales to fit the width of the screen to project a 16:9 screen image.
- 4:3 — The input source scales to fit the screen and projects a 4:3 image.

ZOOM—Press and to zoom and view the image.

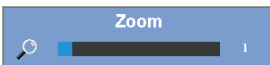

Adjust the image scale by pressing or and press ✓ to view on your remote control only.

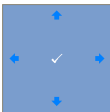

ZOOM NAVIGATION—Press ✓ to activate the Zoom Navigation menu.

Use to navigate the projection screen.

PROJECTOR SETTINGS—Select and press ✓ to activate projector settings. The projector settings menu provides the following options:

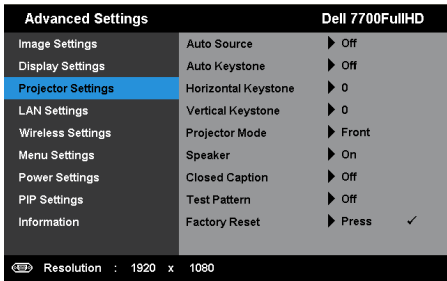

AUTO SOURCE—Select **Off** (the default) to lock the current input signal. If you press the **Source** button when the **Auto Source** mode is set to **Off**, you can manually select the input signal. Select **On** to auto detect the available input signals. If you press the **Source** button when the projector is on, it automatically finds the next available input signal.

AUTO KEYSTONE—Select **On** to automatically adjust image distortion caused by tilting the projector.

HORIZONTAL KEYSTONE—Use and to adjust the image horizontal keystone.

VERTICAL KEYSTONE—Use and to adjust the image vertical keystone.

PROJECTOR MODE—Allows you to select the projector mode, depending upon how the projector is mounted.

- Rear Projection-Desktop — The projector reverses the image so that you can project from behind a translucent screen.
- Rear Projection-Ceiling Mount — The projector reverses and turns the image upside down. You can project from behind a translucent screen with a ceiling-mounted projection.
- Front Projection-Desktop — This is the default option.
- Front Projection-Ceiling Mount — The projector turns the image upside down for ceiling-mounted projection.





SPEAKER—Select **On** to enable the speaker. Select **Off** to the disable speaker.

CLOSED CAPTION—Select **On** to enable close caption and activate the closed caption menu. Select appropriate closed caption options: CC1, CC2, CC3, and CC4.

 **NOTE:**

- 1 Closed caption option is available for NTSC only.
- 2 Closed captioning can only be enabled via S-Video and Composite Video inputs.

TEST PATTERN—Test Pattern is used to test focus and resolution.

You can enable or disable the **Test Pattern** by selecting **Off**, **1**, or **2**. You can also invoke the Test Pattern 1 by pressing and holding down  and  buttons on the control panel simultaneously for 2 seconds. You can also invoke the test pattern 2 by pressing and holding down  and  buttons on the control panel simultaneously for 2 seconds.

Test Pattern 1:

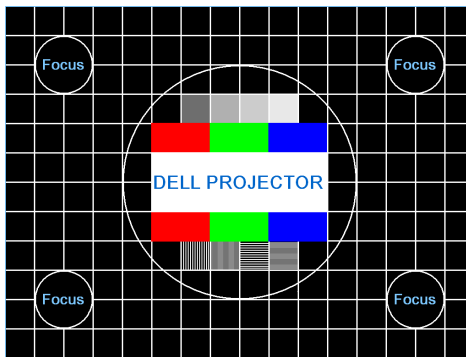

Test Pattern 2:

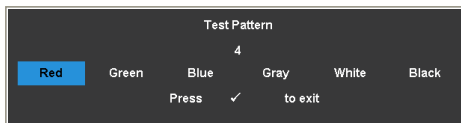

FACTORY RESET—Select and press  to reset all settings to its factory default. The below warning message appears:





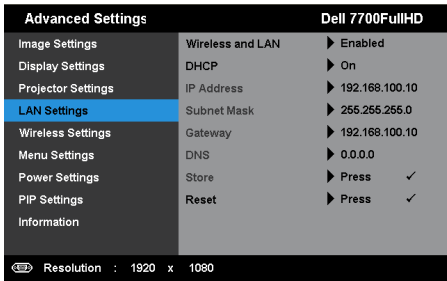

Reset items include both computer sources and Video source settings.

LAN SETTINGS—Select and press  to activate LAN settings. The LAN settings menu provides the following options:



WIRELESS AND LAN—Select **Enabled** to activate the Wireless and LAN function.

DHCP—If a DHCP server exists in the network to which the projector is connected, the IP address will automatically be acquired when you select DHCP On. If DHCP is Off, manually set the IP Address, Subnet Mask, and Gateway. Use  and  to select the number of IP address, Subnet Mask, and Gateway. Key in enter to confirm each number and then use  and  to set the next item.

IP ADDRESS—Automatically or manually assigns the IP address to the projector connected to the network.









SUBNET MASK—Configure the Subnet Mask of the network connection.

GATEWAY—Check the Gateway address with your network/system administrator if you configure it manually.

DNS—Check the DNS Server IP address with your network/system administrator if you configure it manually.

STORE—Press  to save the changes made in network configuration settings.

 **NOTE:**

- Use  and  buttons to select IP Address, Subnet Mask, Gateway, DNS, and Store.
- Press the  button to enter IP Address, Subnet Mask, Gateway, or DNS to set the value. (The selected option is highlighted in blue)
 - Use  and  buttons to select the option.
 - Use  and  buttons to set the value.
 - After the setup is complete, press the  button to exit.

3. After the IP Address, Subnet Mask, Gateway, and DNS is set up, select **Store** and press button to store the settings.
4. If you select **Store** without pressing the **Enter** button, the system will keep the original settings.

RESET—Press to reset network configuration.

WIRELESS SETTINGS—Select and press to activate wireless settings. The wireless settings menu provides the following options:

Advanced Settings	Dell 7700FullHD	
Image Settings	Wireless	▶ Connected
Display Settings	DHCP Server	▶ Auto
Projector Settings	Start IP Address	▶ 192.168.100.11
LAN Settings	End IP Address	▶ 192.168.100.254
Wireless Settings	Subnet Mask	▶ 255.255.255.0
Menu Settings	Gateway	▶ 192.168.100.10
Power Settings	DNS	▶ 192.168.100.10
PIP Settings	Store	▶ Press
Information	Reset	▶ Press

Resolution : 1920 x 1080

WIRELESS—Default option is **Connected**. Select **Disconnected** to disable the wireless connection.



NOTE: It is recommended to use the default settings for **Wireless Connect**.

DHCP SERVER—Allows you to enable DHCP server of the wireless.

START IP ADDRESS—Automatically or manually assigns the Start IP address of the DHCP server to the projector connected to the wireless.

END IP ADDRESS—Automatically or manually assigns the End IP address of the DHCP server to the projector connected to the wireless.

SUBNET MASK—Configure the Subnet Mask of the wireless connection.

GATEWAY—Check the Gateway address with your network/system administrator if you configure it manually.







DNS—Check the DNS Server IP address with your network/system administrator if you configure it manually.

STORE—Press to save the changes made in wireless configuration settings.



NOTE:

1. Use and buttons to select IP Address, Subnet Mask, Gateway, DNS, and Store.
2. Press the button to enter IP Address, Subnet Mask, Gateway, or DNS to set the value. (The selected option is highlighted in blue)

- a Use  and  buttons to select the option.
 - b Use  and  buttons to set the value.
 - c After the setup is complete, press the  button to exit.
3. After the IP Address, Subnet Mask, Gateway, and DNS is set up, select **Store** and press  button to store the settings.
 4. If you select **Store** without pressing the **Enter** button, the system will keep the original settings.

RESET—Press  to reset wireless configuration.

MENU SETTINGS—Select and press  to activate the menu settings. The menu settings consists of the following options:

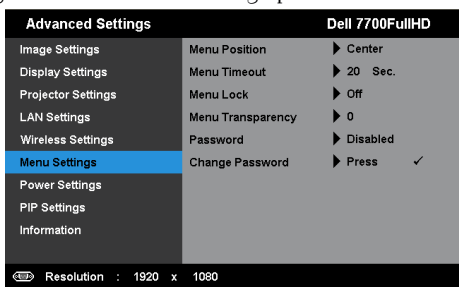

MENU POSITION—Allows you to change the position of the OSD menu on the screen.

MENU TIMEOUT—Allows you to adjust the time for an OSD timeout. By default, the OSD disappears after 20 seconds of non-activity.

MENU LOCK—Select **On** to enable the Menu Lock and hide the OSD menu. Select **Off** to disable the Menu Lock. If you want to disable the Menu Lock function and have the OSD disappear, press the **Menu** button on the control panel or remote control for 15 seconds, and then disable the function.

MENU TRANSPARENCY—Select to change the transparency level of the OSD background.

PASSWORD—When Password Protect is enabled, a Password Protect screen requesting you to enter a password will be displayed when the power plug is inserted into the electrical output and the power for the projector is first turned on. By default, this function is disabled. You can enable this feature by selecting **Enabled**. If the password has been set before, key in the password first and select the function. This password security feature will

be activated the next time you turn on the projector. If you enable this feature, you will be asked to enter the projector's password after you turn on the projector:

1 First time password input request:

- a** Go to **Menu Settings**, press **✓** and then select **Password** to **Enabled** the password settings.

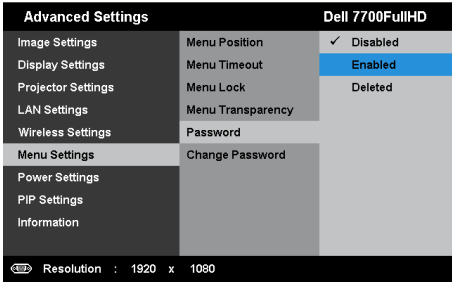

- b** Enabling the Password function will pop up a change screen. Key in a 4-digit number from the screen and press **✓**.

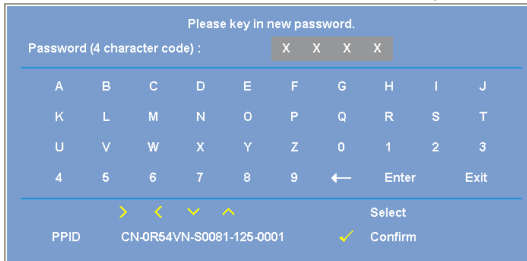

- c** To confirm, enter the password again.
 - d** If the password verification is successful, you may resume with accessing the projector's functions and its utilities.
- 2** If you have entered an incorrect password, you will be given another two chances. After three invalid attempts, the projector will automatically turn off.



NOTE: If you forget your password, contact DELL™ or a qualified service personnel.

- 3** To disable the password function, select the **Disabled** option to close the function.
- 4** To delete the password, select the **Deleted** option.

CHANGE PASSWORD—Key in the original password. Then, enter the new password and confirm the new password again.

Please key in the original password.

Password (4 character code) : X X X X

A	B	C	D	E	F	G	H	I	J
K	L	M	N	O	P	Q	R	S	T
U	V	W	X	Y	Z	0	1	2	3
4	5	6	7	8	9	←	Enter	Exit	

➤ ⏪ ⏩ ⏴ ⏵ Select
 PPID CN-0R54VN-S0081-125-0001 ✔ Confirm

Please key in new password.

Password (4 character code) : X X X X

A	B	C	D	E	F	G	H	I	J
K	L	M	N	O	P	Q	R	S	T
U	V	W	X	Y	Z	0	1	2	3
4	5	6	7	8	9	←	Enter	Exit	

➤ ⏪ ⏩ ⏴ ⏵ Select
 PPID CN-0R54VN-S0081-125-0001 ✔ Confirm

Please key in new password again.

Password (4 character code) : X X X X

A	B	C	D	E	F	G	H	I	J
K	L	M	N	O	P	Q	R	S	T
U	V	W	X	Y	Z	0	1	2	3
4	5	6	7	8	9	←	Enter	Exit	

➤ ⏪ ⏩ ⏴ ⏵ Select
 PPID CN-0R54VN-S0081-125-0001 ✔ Confirm

POWER SETTINGS—Select and press to activate power settings. The power settings menu provides the following options:

Advanced Settings	Dell 7700FullHD	
Image Settings	Quick Shutdown	▶ Off
Display Settings	Power Saving	▶ 120 min
Projector Settings	Wireless	▶ Off when Standby
LAN Settings	VGA Output	▶ Off when Standby
Wireless Settings	Lamp Mode	▶ Normal
Menu Settings	Lamp Hour Reset	▶ Press <input checked="" type="checkbox"/>
Power Settings		
PIP Settings		
Information		
Resolution : 1920 x 1080		

QUICK SHUTDOWN—Select **On** to turn off the projector with a single press of the Power button. This function allows the projector to quickly power off with an accelerated fan speed. Slightly higher acoustic noise is expected during quick power off.



NOTE: Before you turn on the projector again, wait for 60 seconds to allow the internal temperature to stabilize. The projector will take a longer time to turn on if you try to power on immediately. Its cooling fan will run at full speed for about 30 seconds to stabilize the internal temperature.

POWER SAVING—Select **Off** to disable Power Saving mode. By default, the projector is set to enter power saving mode after 120 minutes of no activity. A warning message appears on screen showing a 60 seconds countdown before switching to power saving mode. Press any button during the countdown period to stop the power-saving mode.

You can also set a different delay period to enter power saving mode. The delay period is the time you want the projector to wait without an input signal. Power saving can be set to 30, 60, 90, or 120 minutes.

If an input signal is not detected during the delay period, the projector turns off. To turn on the projector press the Power button.

WIRELESS—Select **Always On** or **Off when Standby** to set the Wireless/LAN module on/off while the projector is standby status.

VGA OUTPUT—Select **Always On** or **Off when Standby** the VGA output feature at projector standby status.

LAMP MODE—Allows you to select between **Normal** or **ECO** mode.

Normal mode operates at full power level. ECO mode operates at a lower power level which may provide longer lamp life, quieter operation, and dimmer luminance output on the screen.

LAMP HOUR RESET—Press  and select the **Confirm** option to reset the lamp hour.

PIP SETTINGS—Select and press ✓ to activate pip settings. The pip settings menu provides the following options:

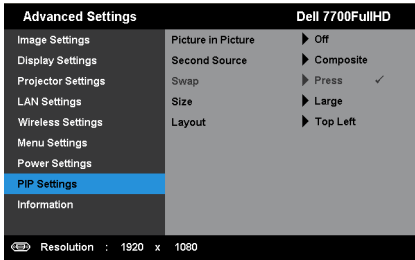

PICTURE IN PICTURE—Select **On** to enable the picture in picture display. Select **Off** to disable the feature.

SECOND SOURCE—Allows you to select the possible second source is available in the OSD selection depending on the current primary input source. See "PIP Combination Sources" on page 113.

SWAP—Press ✓ to swapping the first and second source displays.

SIZE—Allows you to adjust the image size of the second source. The options are: **Small**, **Mid**, **Large**, and **Half**.

LAYOUT—Allows you to change the second source position to the four different corners. The options are: **Top Left**, **Top Right**, **Bottom Left**, and **Bottom Right**.

INFORMATION—The information menu displays the current projector settings.

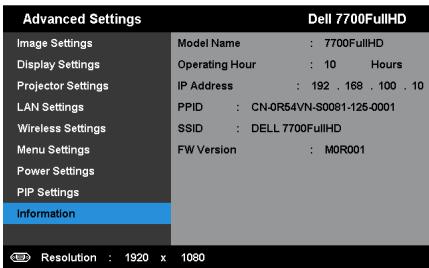

LANGUAGE

Allows you to set the language for the OSD. Press  to activate the Language menu.

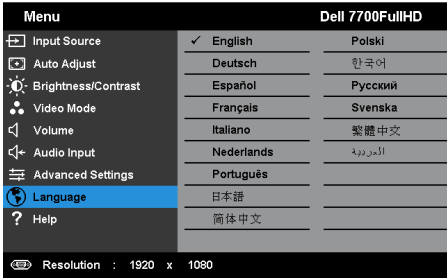

HELP

If you encounter problems with your projector, you can access the help menu for troubleshooting.

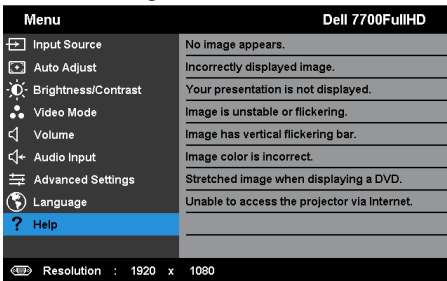

Wireless Networking Installation



NOTE: Your computer must have the following minimum system requirements:

Operating System:

- Windows

Microsoft Windows XP™ Home or Professional Service pack 2 (32-bit recommended), Windows Vista 32-bit, and Windows® 7 Home or Professional 32-bit or 64-bit

- MAC

MacBook and above, MacOS 10.5 and above

Minimum Hardware:

a Intel Dual Core 1.8 MHz or higher

b 256 MB of RAM required, 512 MB or more recommended

c 10 MB of available hard-disk space

d nVIDIA or ATI graphic card must with 64 MB VRAM or above

e Ethernet adapter (10 / 100 bps) for an Ethernet connection

f A supported WLAN adapter for a WLAN connection (any NDIS-compliant 802.11b or 802.11g or 802.11n WiFi device)

Web browser

Microsoft Internet Explorer 6.0 or 7.0 (recommended) or 8.0, Firefox 2.0, Safari 3.0, and above

Enable Wireless on the Projector

In order to use your projector wirelessly, you need to complete the steps below:

- 1 Install the optional wireless dongle. See "Installing the Optional Wireless Dongle" on page 11.
- 2 Connect the power cable to the wall outlet and press the power button.

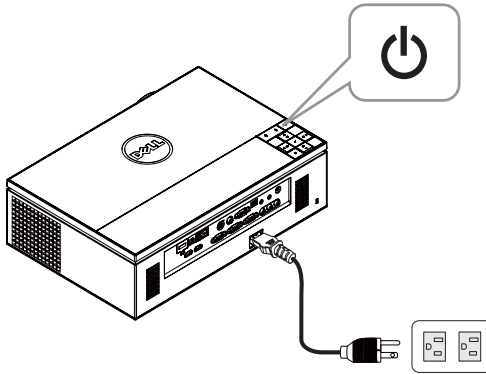

- 3 Press the Menu button on your projector control panel or remote control.

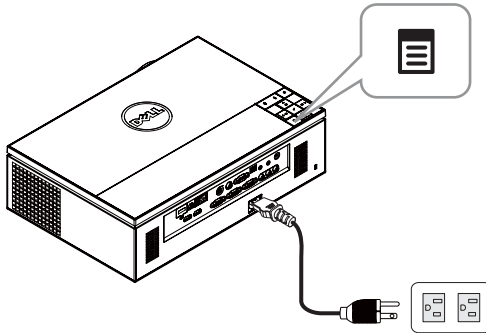

NOTE: Use , ,  and  buttons to navigate and  to select.

- 4 The wireless connection default is **Enabled**. See "Wireless Settings" on page 48.
- 5 Access the **INPUT SOURCE** menu, select **Wireless/USB** and then select **Wireless Display** on the sub-menu. See "INPUT SOURCE WIRELESS/USB" on page 38.

The Wireless Guide Screen shown below appears:



NOTE: If wireless connection is disabled, then follow these steps to set up: **ADVANCED SETTINGS** → **Wireless Settings** → **Wireless** → **Connected**. The image input source will be automatically switched to wireless screen when wireless option is selected in this step.

Advanced Settings		Dell 7700FullHD
Image Settings	Wireless	▶ Connected
Display Settings	DHCP Server	▶ Auto
Projector Settings	Start IP Address	▶ 192.168.100.11
LAN Settings	End IP Address	▶ 192.168.100.254
Wireless Settings	Subnet Mask	▶ 255.255.255.0
Menu Settings	Gateway	▶ 192.168.100.10
Power Settings	DNS	▶ 192.168.100.10
PIP Settings	Store	▶ Press ✓
Information	Reset	▶ Press ✓

Resolution : 1920 x 1080

- 6 Take note of the **LOGIN CODE**, **NETWORK NAME (SSID)**, and **IP ADDRESS**. You will need these information to log in later.

Install the Wireless Application Software on Your Computer

7 Connect your computer to the 7700FullHD wireless network.

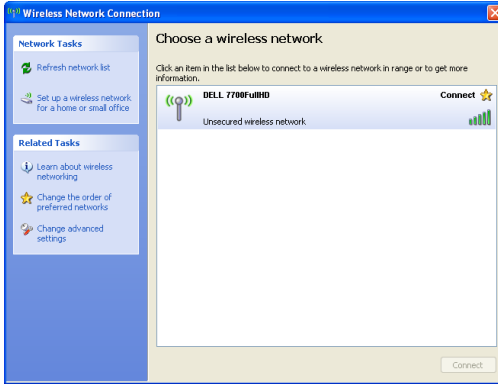

NOTE:

- Your computer must have wireless network function to detect the connection.
- When you connect to the 7700FullHD wireless network, you will lose wireless connectivity with other wireless networks.

NOTE: Remember to turn off all proxies. (In Microsoft® Windows Vista: Click **Control Panel** → **Internet Options** → **Connections** → **LAN Settings**)

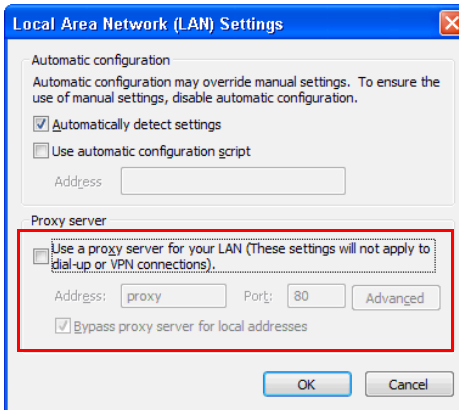

8 Open your Internet browser. You will be automatically directed to the 7700FullHD Web Management web page.



NOTE: If the web page does not load automatically, enter the IP address (default IP address is 192.168.100.10) noted from the projector's screen in the browser's address bar.

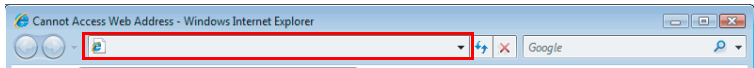

- 9 The 7700FullHD Web Management page opens. For first time use, click Download.

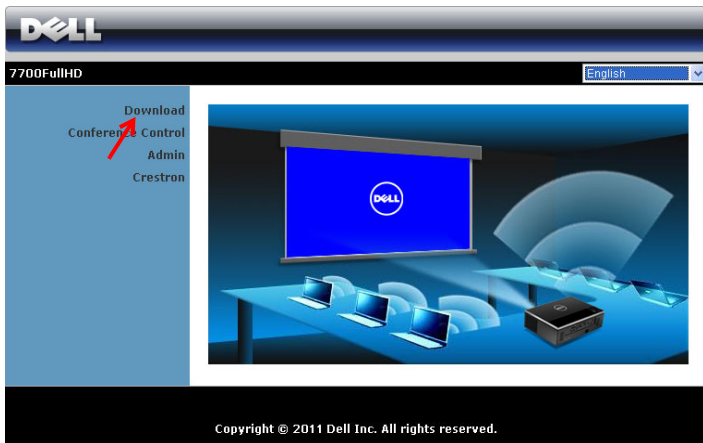

- 10 Select the appropriate operating system, then click Download.

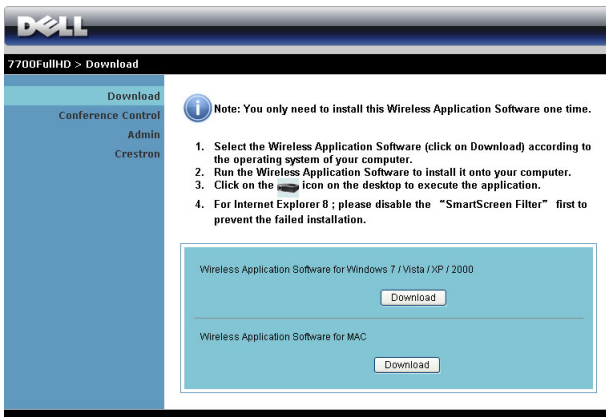

- 11 Click **Run** to proceed with the one-time installation of the software.

 **NOTE:** You may choose to save the file and install it at a latter time. To do this, click **Save**.

 **NOTE:** If you are unable to install the application because of inadequate rights on the computer, please contact your network administrator.

- 12 The installation software will launch. Follow the on-screen instructions to complete setup.

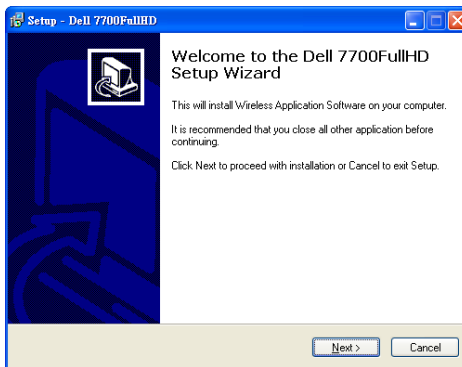
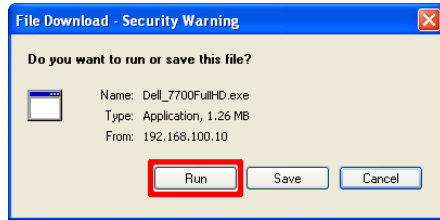

Launch the Wireless Application

Once the installation is complete, the program will launch and search automatically. If the program not launch automatically, you can double-click the  icon on the desktop to start the application. Select the **Dell 7700FullHD**, and then click **OK**.



Login

To communicate with your projector, enter the Login Code provided in Step 6 of Wireless Networking Installation, then click **OK**.

















NOTE: If the **IP Address** is not detected, enter the **IP Address** displayed at the bottom left corner of the screen.

Understanding the Buttons





After a successful log in, the following screen appears:

Projection Mode







	Item	Description
1	Status Bar	Displays IP and LOGIN CODE information.
	 Menu	Click to activate the application menu.
	 Minimize button	Click to minimize the application.
	 Close button	Click to exit the application.
2	Status Mode	
	 Projection Mode	Click to activate the projection mode.
	 Video Mode	Click to activate the video mode.
3	Controls Toolbar	
	 Full screen	Click to project the image in full screen.
	 Split 1	Click to project the image in the upper left corner of the screen.
	 Split 2	Click to project the image in the upper right corner of the screen.
	 Split 3	Click to project the image in the lower left corner of the screen.
	 Split 4	Click to project the image in the lower right corner of the screen.
	 Stop	Click to stop projection.
	 Pause	Click to pause projection.
	 Audio Projection	Click to enable audio projection.
4	Connection Status	
	 Connection Icon	Blinks when projection is in progress.

Projecting the Presentation

- To project the presentation, click any of the projection buttons .
- To pause the presentation, click . The icon turns green.
- To continue the presentation, click  again.
- To audio projection the presentation, click . See "Audio Projection Installation" on page 71.
- To stop the presentation, click .

Video Mode



Item	Description	
1	Control Toolbar	
	Open	Click to open folder and searching the video or music file.
	Play	Click to starting player.
	Stop	Click to stop player.
	Mute	Click to mute/un-mute.



NOTE: The following information is for wireless data presentation mode only. Image display could be slow or not displayed smoothly if displaying a video clip or animation. Refer to the frame-rate table below for reference:

Frame Rate of Wireless Presentation

Screen Variation % ¹	Estimated frames per second ²
<5 %	30 ³
<10%	28 ³
<20%	26 ³
<40%	25 ³
<75%	22 ³
<=100%	20 ³

 **NOTE:**

- 1 The percentage of screen variation is based on 1024 x 768. Example to display a 320 x 240 video clip on 1024 x 768 desktop, the screen variation is 9.8%.
- 2 Actual frame rate could be different depending on factors such as network environment, image content, signal conditions, locations, and CPU performance.
- 3 Under clean WLAN environment using 802.11g connection, and no screen stretching.
- 4 Compressed to 1024 x 768 and under 802.11g.

 **NOTE:** Your computer will not enter S1 (standby mode) / S3 (sleep mode) / S4 (hibernate mode) when running a wireless, USB Display, or USB Viewer presentation.

Using the Menu

Click  to display the menu.



WEB MANAGEMENT—Click to open the Web Management page. See "Managing the Projector From Web Management" on page 78.

SEARCH FOR PROJECTOR—Click to search and connect to wireless projector.

MAKE APPLICATION TOKEN—Click to make application token. See "Make Application Token" on page 99.

INFO—Click to display system information.

HOTKEY—Click to display the hotkey information.

ABOUT—Click to display the application version.

EXIT—Click to close the application.

Presentation to Go (PtG) Installation

Minimum system requirements to install PtG are as follow:

Operating System:

- Windows

Microsoft Windows XP™ Home or Professional Service pack 2/3 (32-bit recommended), Windows Vista 32-bit, or Windows® 7 Home or Professional 32-bit or 64-bit

- Office 2003 or Office 2007

In order to use your USB Viewer, you need to complete the steps below:

"Wireless and LAN" option and "Wireless connection" default are enabled.

- 1 Plug the USB Flash drive to your projector.



NOTE:

- Supports only the JPEG format photo within 10 MB x 40 M pixels.
- The PtG converter can convert your PowerPoint files into PtG files. See "Install the PtG Converter Application Software on Your Computer" on page 69.
- You can download the "PtG Converter - Lite" from the Dell Support site at support.dell.com.

- 2 At INPUT SOURCE menu, select Wireless/USB and then select USB Viewer on the sub-menu. See "INPUT SOURCE WIRELESS/USB" on page 38.



NOTE:

- 1 When the Wireless and LAN function is disabled , Go to **LAN Settings** menu, select the "**Enabled**" in the "**Wireless and LAN**" option to activate the Wireless and LAN function.
- 2 When the Wireless connection is disconnected, Go to **Wireless Settings** menu, select the "**Connected**" in the **Wireless** option to enable wireless connection.

PtG Viewer

System will stay in this page when ready.

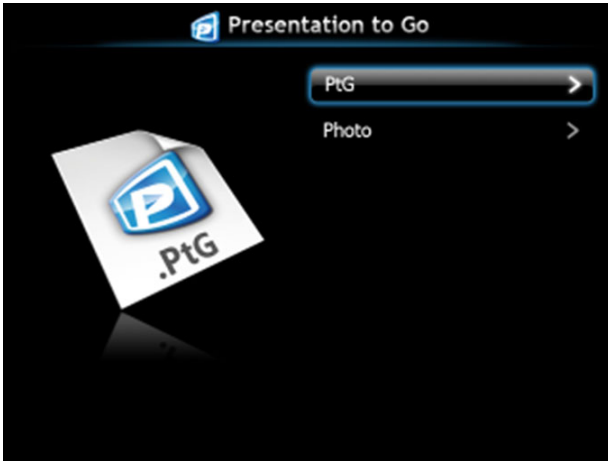
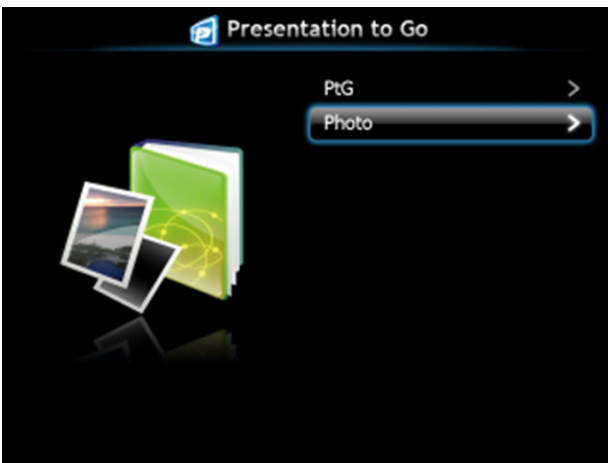



Photo Viewer



PtG/Photo Function Introduction

Show valid PtG and Photo files which are stored in the USB disk.

 **NOTE:** If only one disk is detected, the system will skip this step.

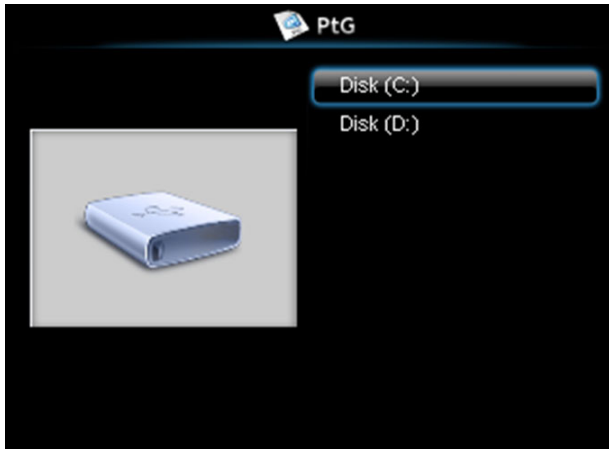

PtG Overview





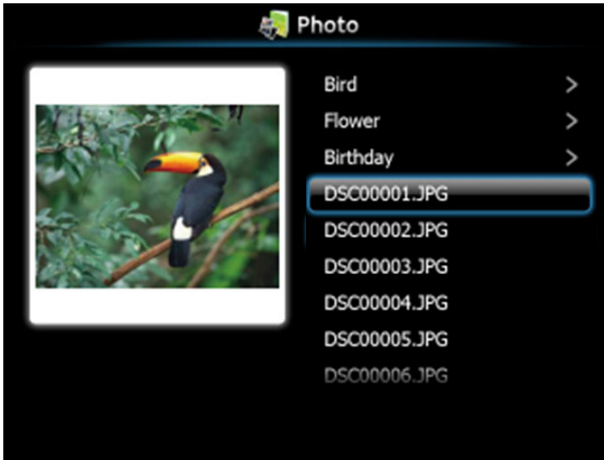

Photo Overview



NOTE: Supports 14 languages of photo files name format (Languages: English, Dutch, French, German, Italian, Japanese, Korean, Polish, Portuguese, Russian, Simplified Chinese, Spanish, Swedish, and Traditional Chinese).

Buttons-Introduction

Use the up, down, and left buttons to navigate and ✓ button on your projector's control panel or remote control to select.

Button	Up 	Down 	Left 	Right 	Enter 
PtG function	Up	Down	Back	No function	Enter
PtG Playback	Pre Page	Next Page	Back	No function	Next Pause
Photo function	Up	Down	Back	No function	Enter
Photo Playback	Pre Page	Next Page	Back	No function	No function

NOTE: If you enter the OSD menu while using PtG, PtG navigation by the up, down, and left buttons will not function.

Install the PtG Converter Application Software on Your Computer

Please follow the on-screen instructions to complete the setup.

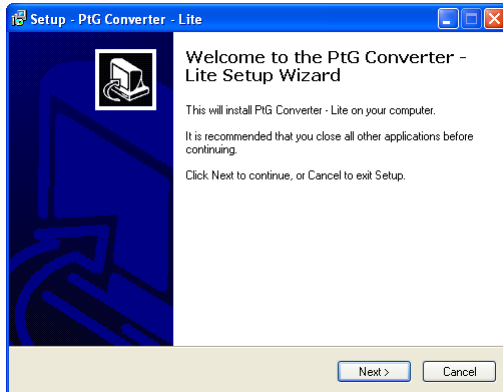

NOTE: You can download the "PtG Converter - Lite" from the Dell Support site at support.dell.com.

Using the PtG Converter

- 1 Launch the "PtG Converter - Lite.exe" or double-click the  icon on the desktop to start the application.

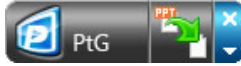

- 2 Click  to select a PowerPoint file and start conversion.

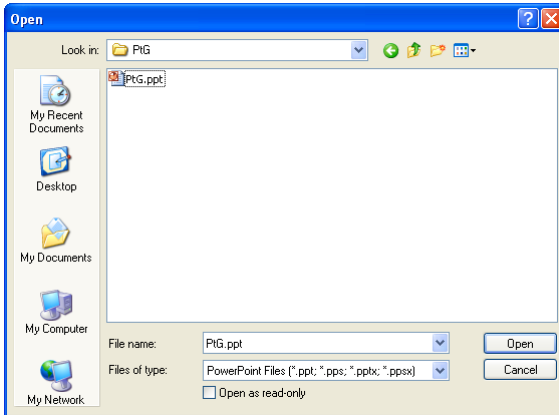

- 3 Click **Browse** button to select the storage location and then press **OK**.

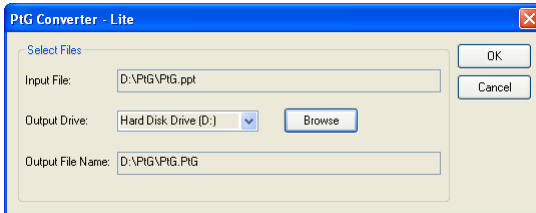

NOTE:

- 1 If your computer does not have MS PowerPoint installed, file convert will fail.
- 2 PtG converter only supports up to 20 pages.
- 3 PtG converter only supports conversion of .ppt files to .PtG files.

Audio Projection Installation

Audio Projection only supports the **Wireless Display** and **LAN Display** input source.

Minimum system requirements as follow:

Operating System:

- Windows
Microsoft Windows XP™ Home or Professional Service pack 2/3 (32-bit recommended), Windows Vista 32-bit, or Windows® 7 Home or Professional 32-bit or 64-bit
- MAC
MacBook Pro and above, MacOS 10.5 and above

Minimum Hardware:

- a** Intel® Core™ i5-460 MHz (2.53 GHz/Turbo 2.8 GHz) or greater
- b** 1 GB DDR3 VRAM independent graphics card or more recommended
- c** 2 GB dual channel DDR3 SDRAM memory at 1066 MHz required or more recommended
- d** Gigabit Ethernet
- e** Integrated 802.11 b/g/n Wi-Fi Device for a WLAN connection



NOTE: If your computer does not meet the minimum hardware requirements, audio projection may have lag or noise. Meet the recommended system requirements to have optimized performance of audio projection.



NOTE: If you want to use wireless for audio projection, need installed the optional wireless dongle. See "Installing the Optional Wireless Dongle" on page 11.



NOTE: The audio projector function needs an extra driver to be installed. A pop-up screen will alert you if your computer needs to install the driver. You can download the Audio Projection Driver from the Dell Support site at support.dell.com.



NOTE: Ports / Protocol for connection to the projector for projection via Ethernet:

UDP:	1047,	(backup: 1048, 1049)
TCP:	3268, 515, 1688, 1041	(backup: 389, 8080, 21)

Enable Wireless or LAN on the Projector

- 1 Connect the power cable and turn on the projector by pressing the power button.

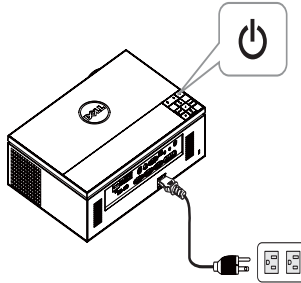

- 2.1 If the LAN is used for audio projection, follow these steps to enable Wireless and LAN function (default is Enabled): **Advanced Settings** → **LAN Settings** → **Wireless and LAN** → **Enabled**.

Advanced Settings		Dell 7700FullHD
Image Settings	Wireless and LAN	▶ Enabled
Display Settings	DHCP	▶ On
Projector Settings	IP Address	▶ 192.168.100.10
LAN Settings	Subnet Mask	▶ 255.255.255.0
Wireless Settings	Gateway	▶ 192.168.100.10
Menu Settings	DNS	▶ 0.0.0.0
Power Settings	Store	▶ Press ✓
PIP Settings	Reset	▶ Press ✓
Information		

Resolution : 1920 x 1080

- 2.2 If the Wireless is used for audio projection, follow these steps to enable wireless connection (default is Connected): **Advanced Settings** → **Wireless Settings** → **Wireless** → **Connected**.

Advanced Settings		Dell 7700FullHD
Image Settings	Wireless	▶ Connected
Display Settings	DHCP Server	▶ Auto
Projector Settings	Start IP Address	▶ 192.168.100.11
LAN Settings	End IP Address	▶ 192.168.100.254
Wireless Settings	Subnet Mask	▶ 255.255.255.0
Menu Settings	Gateway	▶ 192.168.100.10
Power Settings	DNS	▶ 192.168.100.10
PIP Settings	Store	▶ Press ✓
Information	Reset	▶ Press ✓

Resolution : 1920 x 1080

- 3 Access the Input Source menu, select the **Wireless/USB** and then select the **Wireless Display** on the sub-menu.

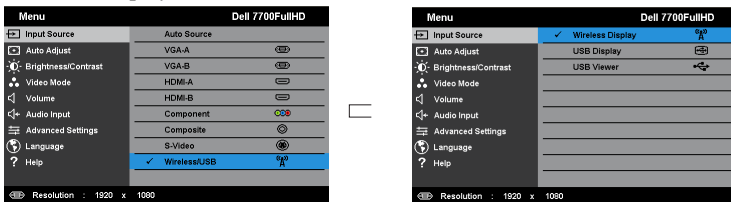

The Wireless Guide Screen shown below appears:

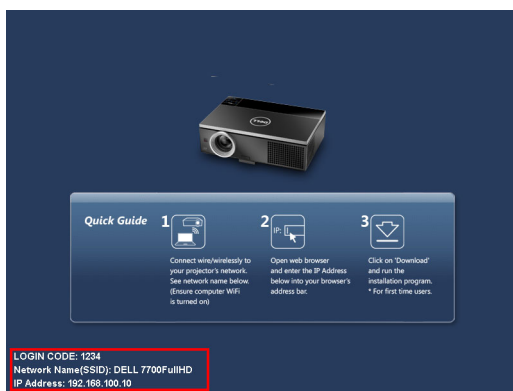

- 4 Take note of the **LOGIN CODE**, **NETWORK NAME (SSID)**, and **IP ADDRESS**. You will need these information to log in later.

Install the Wireless Application Software on Your Computer

- 5 "Wireless Application Software" is required if the Wireless or LAN is used for the Audio Projection set-up. Please download and install the software the first time you use Audio Projection. If it is already installed, skip Step 5 - 6.



NOTE: You only need to install the "Wireless Application Software" once.

- 6 Wireless Application Software download and install steps refer to steps 7 to 12 of the "Wireless Networking Installation" on page 55.

 **NOTE:** If the LAN is used for audio projection, connect the LAN cable to the projector and the computer.

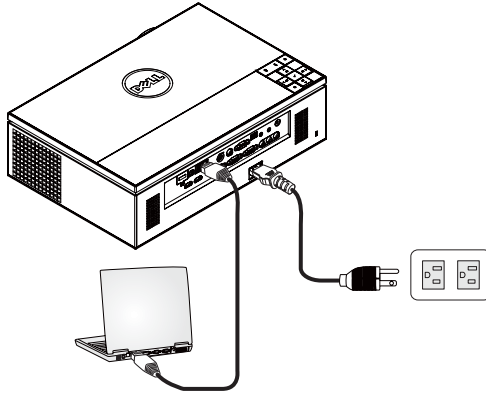

Launch the Wireless Application

- 7 Once the installation is complete, the program will launch automatically. Or you can double-click the icon  on the desktop to start the application.

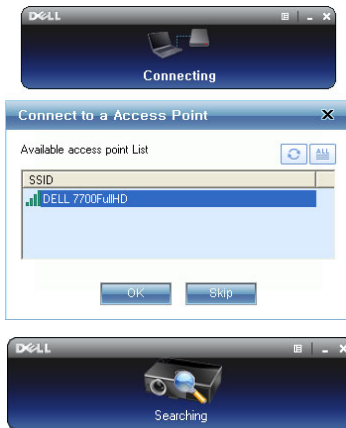

 **NOTE:**

- 1 When you select the LAN for projection, click "Skip".
- 2 When you select the Wireless for projection, select the **Dell 7700FullHD**, and the click "OK".

Login

- 8 To communicate with your projector, enter the Login Code (see Step 4), and then click OK.

 **NOTE:** If the **IP Address** is not detected, enter the **IP Address** displayed at the bottom left corner of the wireless screen.

- 9 You are now logged into the 7700FullHD Wireless Application. Click the "Play" button in the application to starting the LAN or wireless projection.



 **NOTE:** You may use the controls to either project in full screen mode or in split screen mode.

- 10 Click the "Audio Projection" button in the application to enable Audio Projection function.



 **NOTE:** Audio projector function need install extra driver, if your computer do not install driver, will pop-up need install driver message on screen. You can download the "**extra driver**" from the Dell Support site at support.dell.com.

- 11 Executing the Windows Media Player or others audio player software (example: Winamp player...) on your computer.



Video Stream Installation

Video Stream only supports the Wireless Display and LAN Display input source.

Minimum system requirements as follow:

Operating System:

- Windows
Microsoft Windows XP™ Home or Professional Service pack 2/3 (32-bit recommended), Windows Vista™ 32-bit, or Windows® 7 Home or Professional 32-bit or 64-bit
- MAC
MacBook Pro and above, MacOS 10.5 and above

Minimum Hardware:

- a Dual® Core™ 1.8 GHz or greater
- b 64 MB VRAM independent graphics card or more recommended
- c 2 GB DDR SDRAM memory or more recommended
- d Gigabit Ethernet
- e Integrated 802.11 b/g/n Wi-Fi Device for a WLAN connection



NOTE: If your computer does not meet the minimum hardware requirements, video stream may have lag. Meet the recommended system requirements to have optimized performance of the video stream.



NOTE: If you want to use wireless feature, need installed the optional wireless dongle. See "Installing the Optional Wireless Dongle" on page 11.



NOTE: Ports / Protocol for connection to the projector for projection via Ethernet:

UDP:	1047,	(backup: 1048, 1049)
TCP:	3268, 515, 1688, 1041	(backup: 389, 8080, 21)

Video Stream Support Format

File Format	Video Format	Max Resolution	Audio Format
MP4, MOV	H.263	FWVGA (854x480)	AAC LC, LPCM
MP4, MOV	H.264	Up to 720P30	AAC LC, LPCM, MP3
MP4, MOV	MPEG-4	Up to 720P30	AAC LC, LPCM, MP3
ASF	WMV9/VC-1	Up to 720P24	WMA

Enable Wireless or LAN on the Projector

Please refer to "steps 1 to 4 of the Audio Projection Installation" on page 71 for instructions to enable wireless or LAN feature.

Install the Wireless Application Software on Your Computer

Please refer to "steps 5 to 6 of the Audio Projection Installation" on page 73 for instructions to install the Dell Wireless Application Software.

Launch the Wireless Application

Please refer to "step 7 of the Audio Projection Installation" on page 74 for instructions to launching the application..

Login

Please refer to "step 8 of the Audio Projection Installation" on page 75 for instructions to log-in the application.

- 1 You are now logged into the 7700FullHD Wireless Application. Click "Video Mode" button switch to Video Mode screen.



- 2 Click  to select the video or music files and starting player.



NOTE: Select the video or music file, then press Play. The projector will enter hibernate mode first, it will playback the video or music file after a few seconds.

Managing the Projector From Web Management

Configuring the Network Setting

If the projector is connected to a network, you can access the projector using a web browser. For configuring the network setting, refer to "LAN Settings" on page 47.

Accessing Web Management

Use Internet Explorer 6.0 and above or Firefox 2.0 and above and enter the IP address. You can now access Web Management and manage the projector from a remote location.

Home Page

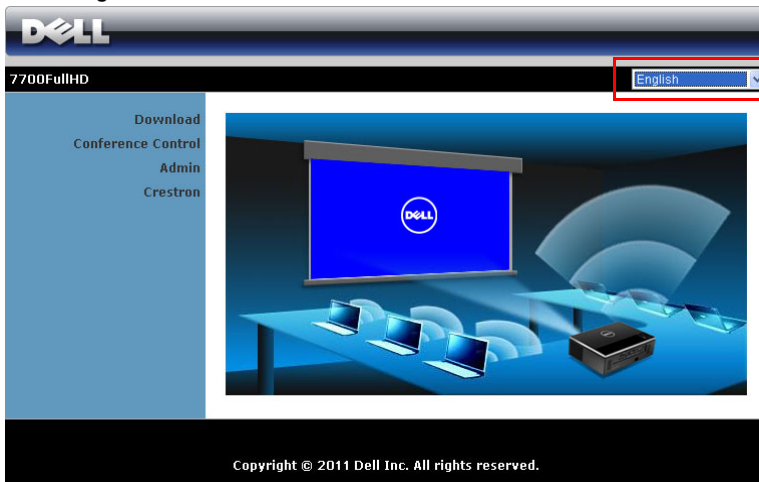

- Access the Web Management Home page by entering the projector's IP address at the web browser. See "LAN Settings" on page 47.
- Select the language for web management from the list.
- Click any menu item on the left tab to access the page.

Download the Wireless Application Software

See also "Wireless Networking Installation" on page 55.

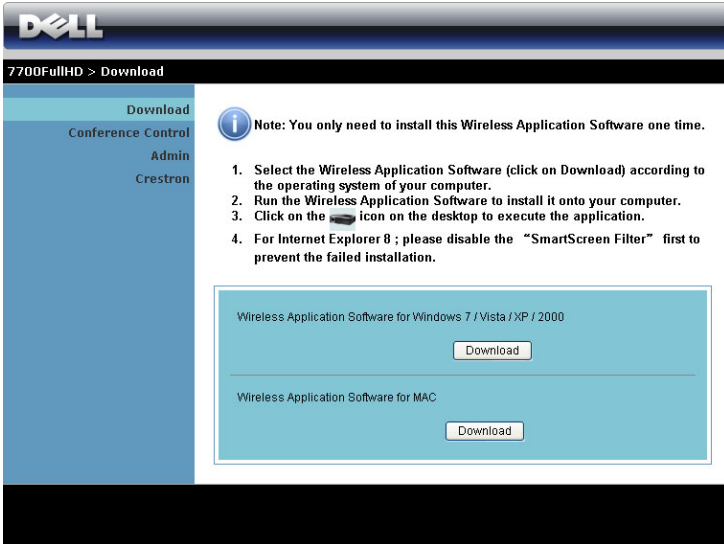

The screenshot shows a Dell website interface. At the top left is the Dell logo. Below it, the breadcrumb path reads "7700FullHD > Download". A left-hand navigation menu lists "Download", "Conference Control", "Admin", and "Crestron". The main content area features an information icon followed by a note: "Note: You only need to install this Wireless Application Software one time." Below the note is a numbered list of four instructions: 1. Select the Wireless Application Software (click on Download) according to the operating system of your computer. 2. Run the Wireless Application Software to install it onto your computer. 3. Click on the [icon] icon on the desktop to execute the application. 4. For Internet Explorer 8 ; please disable the "SmartScreen Filter" first to prevent the failed installation. At the bottom of the content area, there are two download options: "Wireless Application Software for Windows 7 / Vista / XP / 2000" and "Wireless Application Software for MAC", each with a "Download" button.

Click the **Download** button of the corresponding operating system of your computer.

Conference Control

This allows you to host conference presentations from different sources without using projector cables and lets you control how each presentation will appear on screen.

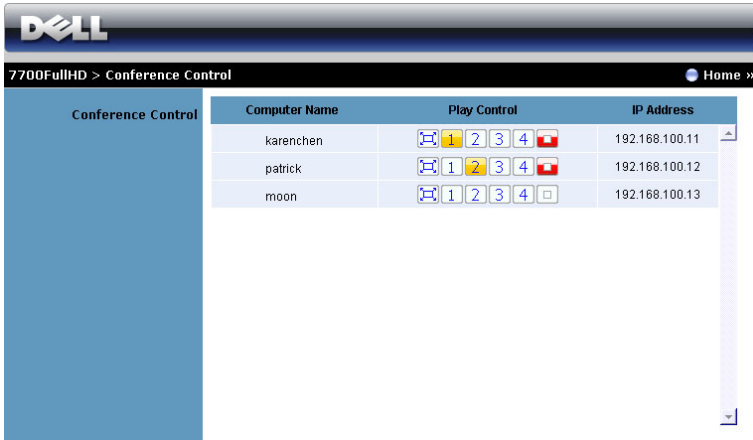

NOTE: Without Conference Play Control, the last user to hit the "Play" button on the application will take control of the full-screen projection.

Computer Name: Lists the computers logged for conference control.

Play Control: Click the buttons to control how each computer's projection will appear on screen.

- Full screen projection — The presentation from the computer occupies the whole screen.
- Split 1 - The presentation from the computer appears on the upper left corner of the screen.
- Split 2- The presentation from the computer appears on the upper right corner of the screen.
- Split 3- The presentation from the computer appears on the lower left corner of the screen.
- Split 4- The presentation from the computer appears on the lower right corner of the screen.
- Stop - Projection from the computer is stopped.

IP Address: Shows each computer's IP Address.

NOTE: To end the conference, click **Home**.

Managing Properties

Admin

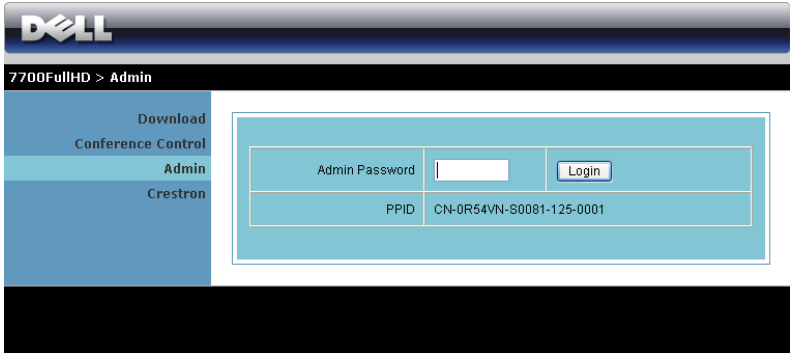

An administrator password is required to access the Admin page.

- **Admin Password:** Enter the administrator password and then click **Login**. The default password is "admin". To change the password, see "Change Passwords" on page 86.

System Status

The screenshot shows the Dell System Status web interface. At the top, there is a Dell logo and a breadcrumb trail: 7700FullHD > Admin > System Status. A 'Home' button is visible in the top right corner. The main content area is divided into a left sidebar and a right main panel. The sidebar contains the following menu items: System Status, Network Setup, Projection Setup, Change Passwords, Reset to Default, Firmware Upgrade, Projector Upgrade, Projector Control Panel, Alert Setting, and a red 'Reboot System' button. The main panel displays three sections of status information:

Network Status	
IP Address	192.168.3.68
Subnet Mask	255.255.255.0
Default Gateway	192.168.3.254
Wire MAC Address	11:22:33:44:55:66

Connection Status	
Projecting Status	Waiting for Projecting
Total Users	0

Projector Status	
Model Name	7700FullHD
Projector Name	
Location	
Contact	
Status	Standby
Lamp Hours	0 hrs

Displays the Network Status, Connection Status, and Projector Status information.

Network Setup

See OSD section on page 47.

System Status					
Network Setup					
Projection Setup					
Change Passwords					
Reset to Default					
Firmware Upgrade					
Projector Upgrade					
Projector Control Panel					
Alert Setting					
Reboot System					
IP Setup	<input checked="" type="radio"/> Obtain an IP address automatically				
	<input type="radio"/> Use the following IP address				
	IP Address	192	168	100	10
	Subnet Mask	255	255	255	0
Default Gateway		192	168	100	10
DNS Server		192	168	100	10
DHCP Server Setup	<input checked="" type="radio"/> Auto				
	<input type="radio"/> Disable				
	Start IP	192	168	100	11
	End IP	192	168	100	254
	Subnet Mask	255	255	255	0
	Default Gateway	192	168	100	10
DNS Server		192	168	100	10
Wireless Setup	Wireless LAN	<input checked="" type="radio"/> Enable			
	<input type="radio"/> Disable				
	Region	--- WORLDWIDE ---			
	SSID	DELL 7700FullHD			
	SSID Broadcast	<input checked="" type="radio"/> Enable			
	<input type="radio"/> Disable				
	Channel	Auto			
Encryption	Disable				
Key					
RADIUS Server Setup	IP Address	192	168	100	10
	Port	1812			
	Key				
GateKeeper	<input type="radio"/> All Pass				
<input checked="" type="radio"/> All Block					
<input type="radio"/> Internet Only					
Set Security For SNMP	Write Community	private			
		Apply	Cancel		

IP Setup

- Choose **Obtain an IP address automatically** to assign an IP address to the projector automatically, or **Use the following IP address** to assign an IP address manually.

DHCP Server Setup

- Choose **Auto** to automatically set up the **Start IP**, **End IP**, **Subnet Mask**, **Default Gateway**, and **DNS Server** address from a DHCP server, or **Disable** to disable this function.

Wireless Setup

- Choose **Enabled** to set up the **Region**, **SSID**, **SSID Broadcast**, **Channel**, **Encryption**, and **Key**. Choose **Disable** to disable the wireless set up.

SSID: Up to maximum length of 32 characters.

Encryption: You can **Disable** WPA key or select one of 64-bit or 128-bit in ASCII or HEX string.

Key: If Encryption is enabled, you have to set key value according to the encryption mode you selected.

RADIUS Server Setup

- Set up the IP address, Port, and Key information.

GateKeeper

- There are three options:

All Pass: Allow users to access the office network via the wireless projector.

All Block: Block users from accessing the office network via the wireless projector.

Internet Only: Block users from the office network, but still reserve Internet connection capability.

Set Security For SNMP

- Setup Write Community information.

Click the **Apply** button to save and apply changes. The projector must be restarted for the changes to take effect.

Projection Setup

7700FullHD > Admin > Projection Setup Home »

System Status Network Setup Projection Setup Change Passwords Reset to Default Firmware Upgrade Projector Upgrade Projector Control Panel Alert Setting Reboot System	Projection Setup	Resolution	720P (1280x720) ▾
		Login Code	<input type="radio"/> Disable <input checked="" type="radio"/> Random <input type="radio"/> Use the following code <input type="text"/>
	Projector Setup	Model Name	7700FullHD
		Projector Name	D05698
		Location	<input type="text"/>
		Contact	<input type="text"/>
		<input type="button" value="Apply"/> <input type="button" value="Cancel"/>	

Projection Setup

- **Resolution:** Allows you to select the resolution. Options are: XGA (1024 x 768) and 720p (1280 x 720).
- **Login Code:** Select how you want the login code to be generated by the projector. There are three options:
 - **Disable:** Login code will not be required when logging in to the system.
 - **Random:** Default is **Random**. Login code will be randomly generated.
 - **Use the following code:** Enter a 4-digit code. This code will be used to log in to the system.

Projector Setup

- Set up the **Model Name**, **Projector Name**, **Location**, and **Contact** information (up to 21 characters for each field).

Click the **Apply** button to save and apply changes. The projector must be restarted for the changes to take effect.

Change Passwords

The screenshot shows the Dell projector's web interface. At the top left is the Dell logo. Below it, a breadcrumb trail reads "7700FullHD > Admin > Change Passwords". On the right side of the breadcrumb trail is a "Home" link with a double arrow. A vertical navigation menu on the left lists several options: "System Status", "Network Setup", "Projection Setup", "Change Passwords" (which is highlighted in light blue), "Reset to Default", "Firmware Upgrade", "Projector Upgrade", "Projector Control Panel", "Alert Setting", and "Reboot System" (with a red power icon). The main content area is titled "Admin" and contains a form with two input fields: "Enter New Password" and "Confirm New Password". An "Apply" button is located to the right of the second input field.

This page allows you to change the administrator password.

- **Enter New Password:** Enter the new password.
- **Confirm New Password:** Enter the password again and click **Apply**.



NOTE: Contact Dell if you forget your administrator password.

Reset to Default

The screenshot shows the Dell Projector Admin interface. At the top, there is a navigation bar with the Dell logo and the breadcrumb path: 7700FullHD > Admin > Reset to Default. A 'Home' button is visible in the top right corner. The left sidebar contains a list of menu items: System Status, Network Setup, Projection Setup, Change Passwords, Reset to Default (highlighted), Firmware Upgrade, Projector Upgrade, Projector Control Panel, Alert Setting, and Reboot System. The main content area displays a confirmation dialog box with a yellow warning icon, the title 'Reset to Default', and the text: 'This will restore the Wireless/Network to factory default settings.' Below the text is an 'Apply' button.

Click the **Apply** button to restore the wireless/network setup to its factory default settings.

Firmware Upgrade

Use the Firmware Upgrade page to update your projector's wireless firmware.

7700FullHD > Admin > Firmware Upgrade Home »

Wireless Firmware Version	W20
Release Date	20111201

Firmware update will take few minutes. Do not interrupt the process once it has begun. The wireless system will auto reboot after update is complete.
Select a file (*.awd) to update:

File Name

System Status
Network Setup
Projection Setup
Change Passwords
Reset to Default
Firmware Upgrade
Projector Upgrade
Projector Control Panel
Alert Setting
Reboot System



NOTE: Please disable and enable wireless/network using the OSD to restart the network card for the projector after firmware upgrade is successful.

To start the firmware update, follow these steps:

- 1 Press **Browse** to select the file to update.
- 2 Click the **Update** button to start. Wait while the system updates the firmware in your device.

Please wait while System burns new firmware into your device.

Warning: It needs to take 5-7 minutes to burn the file you transferred into flash memory. **During this period, any interrupt such as shut down or reboot the system will cause system crash!**

Estimated Time remaining: 414seconds



CAUTION: Do not interrupt the update process as this may cause the system to crash!

- 3 Click **OK** when the update is complete.



Projector Upgrade

Use the Projector Upgrade page to update your projector's firmware.

7700FullHD > Admin > Projector Upgrade Home »

System Status
Network Setup
Projection Setup
Change Passwords
Reset to Default
Firmware Upgrade
Projector Upgrade
Projector Control Panel
Alert Setting
Reboot System

Projector Firmware Version: MOR001

This is used for projector's firmware update. It will take few minutes to complete. Do not interrupt the process once it has begun. Please select a projector firmware file (*.bin) to upgrade.

File Name:



NOTE: Please disable and enable wireless/network using the OSD to restart the network card for the projector after firmware upgrade is successful.



NOTE: Ensure the wireless standby mode is turn on (default is off), follow these steps: Advanced Settings -> Power Settings -> Wireless -> Always On.

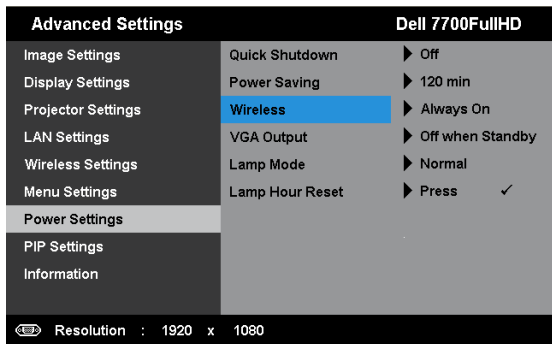

To start the firmware update, follow these steps:

- 1 Plug in the power cord and the projector will enter standby mode.
- 2 Connect the LAN cable to the projector and your computer.
- 3 Open your Internet browser and then enter the IP address (default IP address is 192.168.100.10).
- 4 At Projector Upgrade web page, press **Browse** to select the file to update.

- 5 Click the **Update** button to start. Wait while the system updates the firmware in your device.

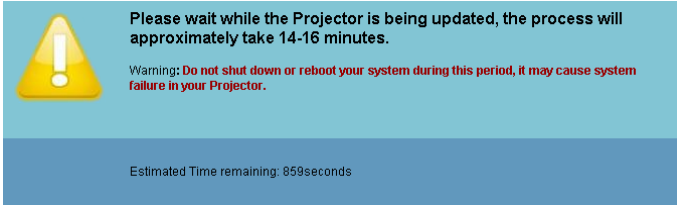

 **NOTE:** **Temp** and **Lamp** LEDs are both lighted up (Amber).

 **CAUTION:** Do not interrupt the update process as this may cause the system to crash!

- 6 Click **OK** when the update is complete.

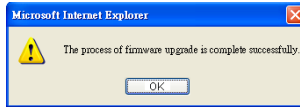

Projector Control Panel

The screenshot shows the Dell Projector Control Panel web interface. At the top, there is a Dell logo and a breadcrumb trail: 7700FullHD > Admin > Projector Control Panel. A 'Home »' link is visible in the top right corner. The left sidebar contains the following navigation options: System Status, Network Setup, Projection Setup, Change Passwords, Reset to Default, Firmware Upgrade, Projector Upgrade, Projector Control Panel (highlighted), Alert Setting, and Reboot System (with a red power icon). The main content area is titled 'Projector Information' and contains the following sections:

- Projector Information:** Projector Status (On) with a Refresh button; Power Saving (Off) with Power ON and Power OFF buttons; Alert Status (Good) with a Clear button.
- Image Control:** Operation Mode (Normal Mode selected, ECO Mode); Projector Mode (Front Projection-Desktop); Source Select (None); Video Mode (Presentation Mode); Blank Screen (Off selected, On); Aspect Ratio (Original selected, 4:3, Wide); Brightness (50) and Contrast (50) both with (0-100) ranges and Set buttons; an Auto Adjust button.
- Audio Control:** Audio Input (HDMI-A); Volume (10) with (0-20) range and Set button; Speaker (On selected, Off); a Factory Reset button.

Projector Information

- **Projector Status:** There are five status: Lamp On, Standby, Power Saving, Cooling, and Warming up. Click **Refresh** to refresh the status and control settings.
- **Power Saving:** Power Saving can be set to Off, 30, 60, 90, or 120 minutes. For more information, see "Power Saving" on page 52.
- **Alert Status:** There are three alert states: Lamp warning, Low lamp life, and Temperature warning. Your projector might lock up in the protection mode if any of the alerts are activated. To exit the protection mode, click **Clear** to clear the Alert Status before you power on your projector.

Image Control

- **Operation Mode:** Allows you to select the operation mode. The two options are: Normal Mode and ECO Mode.
- **Projector Mode:** Allows you to select the projector mode, depending on how the projector is mounted. There are four projection modes: Front Projection-Desktop, Front Projection-Ceiling Mount, Rear Projection-Desktop, and Rear Projection-Ceiling Mount.
- **Source Select:** The Source Select menu allows you to select your projector input source. You can select VGA-A, VGA-B, S-Video, Composite Video, HDMI-A, HDMI-B, RCA Component, Wireless Display, USB Display, or USB Viewer.
- **Video Mode:** Select a mode to optimize the display image based on how the projector is being used:
 - **Presentation:** Best for presentation slides.
 - **Bright:** Maximum brightness and contrast.
 - **Movie:** For viewing movies and photos
 - **sRGB:** Provides a more accurate color representation.
 - **Custom:** User-preferred settings.
- **Blank Screen:** You can select On or Off.
- **Aspect Ratio:** Allows you to select the aspect ratio to adjust how the image appears.
- **Brightness:** Select value to adjust the brightness of the image.
- **Contrast:** Select value to adjust the display contrast.

Click the **Auto Adjust** button to adjust the settings automatically.

Audio Control

- **Audio Input:** Select the input source. Options are: Analog In, HDMI-A, HDMI-B, and Wireless/LAN.
- **Volume:** Select the value (0~20) for audio volume.
- **Speaker:** Select **On** to enable the audio function or select **Off** to disable the audio function.

Click the **Factory Reset** button to restore the factory default settings.

Alert Setting

7700FullHD > Admin > Alert Setting Home »

E-Mail Alert

Enable Disable E-Mail Alert Test

To: @

Cc: @

From: @

Subject:

SMTP Setting

Out going SMTP Server:

Username:

Password:

Alert Condition

Lamp warning

Low lamp life

Temperature warning

E-mail Alert

- **E-mail Alert:** You can set whether to be notified by email (Enable) or not (Disable).
- **To/Cc/From:** You can enter email address of sender (From) and recipients (To/Cc) to receive notification when an abnormality or warning occurs.
- **Subject:** You can enter the subject line of the email.

Click the **E-mail Alert Test** button to test the e-mail alert settings.

SMTP Setting

- **Out going SMTP server, User name, and Password** should be provided by your network administrator or MIS.

Alert Condition

- You can select the abnormalities or warnings to be notified by email. When any of the alert conditions occur, an email will be sent to the recipients (To/Cc).

Click the Save button to save the settings.



NOTE: E-mail alert is designed to work with a standard SMTP server using the default 25 port. It does not support encryption and authentication (SSL or TLS).

Reboot System

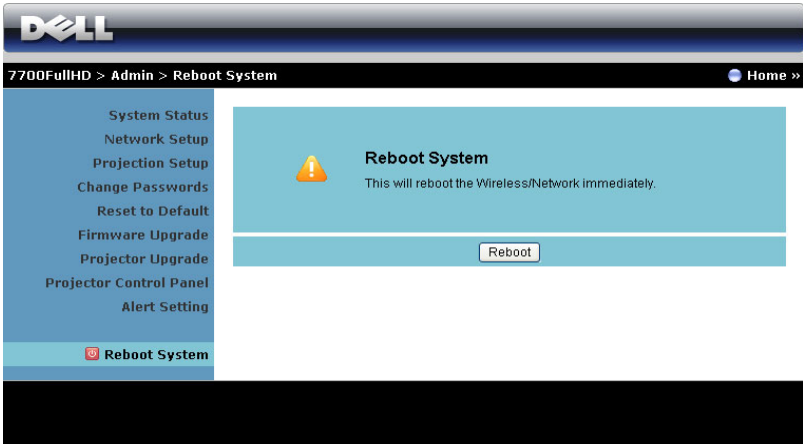

Click Reboot to reboot the system.

Crestron

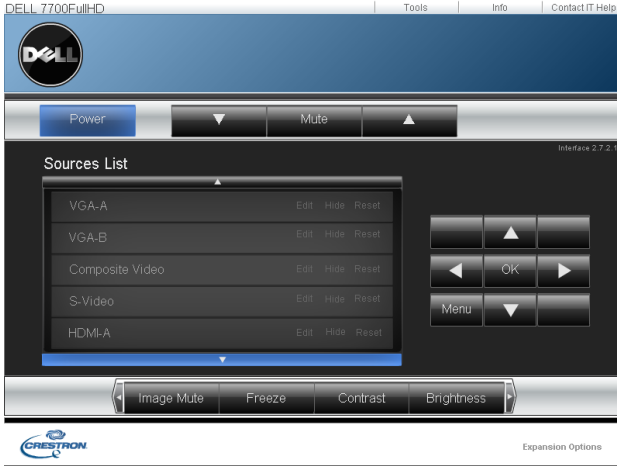

For Crestron function.

FAQS:

I would like to remotely access the projector via the Internet. What is the best setting for the browser?

To have the best setting for the browser, please follow the below steps:

- 1 Open **Control Panel** → **Internet Options** → **General tab** → **Temporary Internet Files** → **Settings** → Select **Every visit to the pages**.
 - 2 Some firewall or anti-virus may block the HTTP application. If possible, turn off the firewall or anti-virus.
-

I would like to remotely access the projector via Internet. What socket port number should I open for it in the firewall?

The following are the TCP/IP socket ports which the projector uses.

UDP/TCP	Port Number	Description
TCP	80	Web configuration (HTTP)
UDP/TCP	25	SMTP: used for email routing between mail servers
UDP/TCP	161	SNMP: Simple Network Management Protocol
UDP	9131	AMX: used for AMX discovery

Why am I unable to access the projector via the Internet?

- 1 Check whether your computer/laptop is connected to the Internet.
 - 2 Check with your MIS or network administrator whether your computer/laptop is in the same subnet.
-

Why am I unable to access the SMTP server?

- 1** Check with your MIS or network administrator whether the SMTP server function is open for the projector and the IP assigned to the projector is allowed to access the SMTP server. The projector's SMTP socket port number is 25, this cannot be changed.
- 2** Check if the outgoing SMTP server, user name, and password are set correctly.
- 3** Some SMTP servers will check whether the mail address of "From" correlates with the "User name" and "Password". For example, you use test@dell.com as the mail address in "From". You should also use test@dell.com account information for the User name and the password to log in the SMTP server.

Why am I unable to receive the test alert email even though the projector already indicates the test mail is already sent?

It could be because the SMTP server recognized the alert mail as a spam mail or because of the SMTP server restriction. Check with your MIS or network administrator for the SMTP server's setting.

Firewall Configuration and FAQ

Q: Why can't I access the Web Management Page?

A: Your computer's firewall configuration may prevent you from accessing the Web Management Web Page. Please refer to the following configuration settings:

Firewall Protection	Configuration
McAfee Security Center	<ol style="list-style-type: none">1 Launch McAfee Security Center (Start > All Programs > McAfee > McAfee Security Center).2 On the personal firewall plus tab, click View the Internet Applications List.3 Find and select Dell 7700FullHD Projector from the list.4 Right-click on its Permissions column.5 Select Allow Full Access from the pop-up menu.
Norton AntiVirus	<ol style="list-style-type: none">1 Open Norton AntiVirus (Start > All Programs > Norton AntiVirus > Norton AntiVirus).2 Click Options menu, then select Norton AntiVirus.3 On the Status page, select Internet Worm Protection.4 Find and select Dell 7700FullHD Projector from the list of programs.5 Right-click on its Internet Access column.6 Select Permit All from the pop-up menu.7 Click OK.
Sygate Personal Firewall	<ol style="list-style-type: none">1 Open Sygate Personal Firewall (Start > All Programs > Sygate > Sygate Personal Firewall).2 From the Running Applications list, find and right-click on Dell 7700FullHD Projector.3 Select Allow from the pop-up menu.

Firewall Protection	Configuration
Windows Firewall	<ol style="list-style-type: none"> 1 Open Windows Firewall (Start > All Programs > Control Panel). Double-click on Windows Firewall. 2 On the General tab, uncheck Don't allow exceptions. 3 On the Exceptions tab, click the Add Program... button. 4 Find and select Dell 7700FullHD Projector from the list of programs, then click OK. 5 Click OK to confirm exceptions settings.
Zone Alarm	<ol style="list-style-type: none"> 1 Open Zone Alarm Firewall (Start > All Programs > Zone Labs > Zone Labs Center). 2 On the Program Control page, find and select Dell 7700FullHD Projector from the list. 3 Right-click on its Access-Trusted column. 4 Select Allow from the pop-up menu. 5 Right-click and select Allow for the Access-Internet, Server-Trusted, and Server-Internet columns.

Make Application Token

 **NOTE:** This feature is only applicable to wireless-enabled models.

The Application Token lets you perform Plug and Show using a USB token.

- 1 From the application software, click  > **Make Application Token**.
- 2 The following screen appears. Click **Next**.



- 3 Plug a flash drive into any of the USB ports on your computer. Select the drive from the list, then click **Next**.

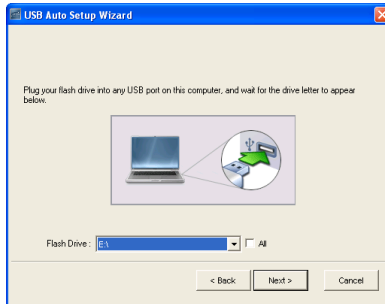

4 Click **Finish** to close the wizard.



Troubleshooting Your Projector



If you experience problems with your projector, see the following troubleshooting tips. If the problem persists, contact Dell™ (see *Contacting Dell™* on page 115).



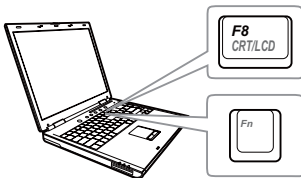

Problem

No image appears on the screen



Possible Solution

- Ensure that the lens cap is removed and the projector is turned on.
 - Ensure that you have chosen the correct input source on the INPUT SOURCE menu.
 - Ensure the external graphics port is enabled. If you are using a Dell™ laptop computer, press   (Fn + F8). For other computers, see your respective documentation. If images are not displayed properly, please upgrade the video driver of your computer. For Dell computers, see support.dell.com.
 - Ensure that all the cables are securely connected. See "Connecting Your Projector" on page 10.
 - Ensure that the pins of the connectors are not bent or broken.
 - Ensure that the lamp is securely installed (see "Changing the Lamp" on page 106).
 - Use **Test Pattern** in the **Projector Settings** of the **Advanced Settings** menu. Ensure that the colors of the test pattern are correct.
-

Problem (continued)	Possible Solution (continued)
Partial, scrolling, or incorrectly displayed image	<ol style="list-style-type: none"> 1 Press the Auto Adjust button on the remote control or the control panel. 2 If you are using a Dell™ portable computer, set the resolution of the computer to Full HD (1920 x 1080): <ol style="list-style-type: none"> a Right-click the unused portion of your Microsoft® Windows® desktop, click Properties, and then select Settings tab. b Verify that the setting is 1920 x 1080 pixels for the external monitor port. c Press   (Fn+F8). <p>If you experience difficulty in changing resolutions, or if your monitor freezes, restart all the equipment and the projector.</p> <p>If you are not using a Dell™ portable computer, see your documentation. If images are not displayed properly, please upgrade the video driver of your computer. For a Dell computer, see support.dell.com.</p>
The screen does not display your presentation	If you are using a portable computer, press   (Fn+F8).
Image is unstable or flickering	Adjust the tracking in the OSD Display Settings of the Advanced Settings menu (in PC Mode only).
Image has vertical flickering bar	Adjust the frequency in the OSD Display Settings of the Advanced Settings menu (in PC Mode only).
Image color is incorrect	<ul style="list-style-type: none"> • If the display receives the wrong signal output from the graphics card, please set the signal type to RGB in the OSD Image Settings of the Advanced Settings tab. • Use Test Pattern in the Projector Settings of the Advanced Settings menu. Ensure that the colors of the test pattern are correct.

Problem (continued)	Possible Solution (continued)
Image is out of focus	<ol style="list-style-type: none"> 1 Adjust the focus ring on the projector lens. 2 Ensure that the projection screen is within the required distance from the projector (3.28 ft [1.0 m] to 39.37 ft [12.0 m]).
The image is stretched when displaying a 16:9 DVD	<p>The projector automatically detects the input signal format. It will maintain the aspect ratio of the projected image according to input signal format with an Original setting.</p> <p>If the image is still stretched, adjust the aspect ratio in the Display Settings of the Advanced Settings menu in the OSD.</p>
Image is reversed	Select Projector Settings of the Advanced Settings from the OSD and adjust the projector mode.
Lamp is burned out or makes a popping sound	When the lamp reaches its end of life, it may burn out and may make a loud popping sound. If this occurs, the projector does not turn back on. To replace the lamp, see "Changing the Lamp" on page 106.
LAMP light is solid amber	If the LAMP light is solid amber, replace the lamp.
LAMP light is blinking amber	<p>If the LAMP light is blinking amber, the lamp module connection may be disrupted. Please check the lamp module and ensure that it is properly installed.</p> <p>If the LAMP light and the Power light are blinking amber, the lamp driver has failed and the projector will automatically shut down.</p> <p>If the LAMP and TEMP lights are blinking amber and the Power light is solid blue, the color wheel has failed and the projector will automatically shut down.</p> <p>To clear the protection mode, press and hold the POWER button for 10 seconds.</p>

Problem (continued)	Possible Solution (continued)
TEMP light is solid amber	The projector has overheated. The display automatically shuts down. Turn the display on again after the projector cools down. If the problem persists, contact Dell™.
TEMP light is blinking amber	If the projector fan fails, the projector will automatically shut down. Try to clear the projector mode by pressing and holding the Power button for 10 seconds. Please wait for about 5 minutes and try to power up again. If the problem persists, contact Dell™.
The OSD does not appear on the screen	Try to press the Menu button on the panel for 15 seconds to unlock the OSD. Check the Menu Lock on page 49.
The remote control is not operating smoothly or works only within a limited range	The battery may be low. Check if the laser beam transmitted from the remote is too dim. If so, replace with two new AAA batteries.

Guiding Signals

Projector Status	Description	Control Buttons	Indicator	
		Power	TEMP (Amber)	LAMP (Amber)
Standby mode	Projector in Standby mode. Ready to power on.	BLUE Flashing	OFF	OFF
Warming up mode	Projector takes some time to warm up and power on.	BLUE	OFF	OFF
Lamp on	Projector in Normal mode, ready to display an image.  Note: The OSD menu is not accessed.	BLUE	OFF	OFF
Cooling mode	Projector is cooling to shutdown.	BLUE	OFF	OFF
Cooling before Power Saving mode	The projector takes 60 seconds to cool down before entering Power Saving mode.	AMBER	OFF	OFF
Projector overheated	Air vents might be blocked or ambient temperature may be above 35 °C. The projector automatically shuts down. Ensure that the air vents are not blocked and that the ambient temperature is within operational range. If the problem persists, contact Dell.	OFF	AMBER	OFF
Lamp driver overheated	The lamp driver is overheated. The air vents may be blocked. The projector automatically shuts down. Turn the display on again after the projector cools down. If the problem persists, contact Dell.	AMBER	AMBER	OFF
Fan breakdown	One of the fans has failed. The projector automatically shuts down. If the problem persists, contact Dell.	OFF	AMBER Flashing	OFF
Lamp driver breakdown	The lamp driver has failed. The projector automatically shuts down. Unplug the power cord after three minutes and then turn the display on again. If this problem persists, contact Dell.	AMBER Flashing	OFF	AMBER Flashing
Color Wheel breakdown	Color wheel cannot start. The projector has failed and the projector automatically shuts down. Unplug the power cord after three minutes and then turn on the projector. If this problem persists, contact Dell.	BLUE	AMBER Flashing	AMBER Flashing
Lamp failure	Lamp is defective. Replace the lamp.	OFF	OFF	AMBER
Fault - DC supply (+12V)	Power supply has been interrupted. The projector automatically shuts down. Unplug the power cord after three minutes and then turn on the projector. If this problem persists, contact Dell.	AMBER Flashing	AMBER	AMBER
Lamp module connection failed	Lamp module connection may be disrupted. Check the lamp module and ensure that it is properly installed. If the problem persists, contact Dell.	OFF	OFF	AMBER Flashing

Changing the Lamp

CAUTION: Before you begin any of the procedures in this section, follow the Safety Instructions as described on page 8.

Replace the lamp when the message "**Lamp is approaching the end of its useful life in the operation. Replacement suggested! www.dell.com/lamps**" appears on the screen. If this problem persists after replacing the lamp, contact Dell™. For more information, see *Contacting Dell™* on page 115.

CAUTION: Use an original lamp to ensure safe and optimal working condition of your projector.

CAUTION: The lamp becomes very hot when in use. Do not attempt to replace the lamp until the projector has been allowed to cool down for at least 30 minutes.

CAUTION: Do not touch the bulb or the lamp glass at any time. Projector lamps are very fragile and may shatter if touched. The shattered glass pieces are sharp and can cause injury.

CAUTION: If the lamp shatters, remove all broken pieces from the projector and dispose or recycle according to state, local, or federal law. For more information see www.dell.com/hg.

- 1 Turn off the projector and disconnect the power cord.
- 2 Let the projector cool for at least 30 minutes.
- 3 Loosen the two screws that secure the lamp cover, and remove the cover.
- 4 Loosen the two screws that secure the lamp.
- 5 Pull the lamp up by its metal handle.

NOTE: Dell™ may require lamps replaced under warranty to be returned to Dell™. Otherwise, contact your local waste disposal agency for the address of the nearest deposit site.

- 6 Replace with the new lamp.
- 7 Tighten the two screws that secure the lamp.
- 8 Replace the lamp cover and tighten the two screws.
- 9 Reset the lamp usage time by selecting "Yes" for **Lamp Hour Reset** in the **OSD Power Settings** of the **Advanced Settings** menu (see *Power Settings of the*

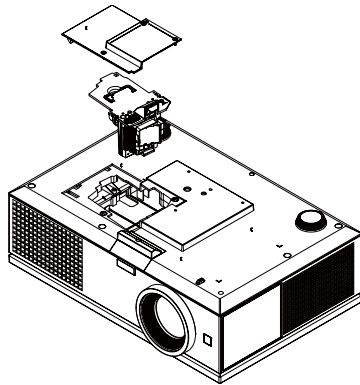

Advanced Setting menu on page 51). When a new lamp module has been changed, the projector will automatically detect and reset the lamp hours.



CAUTION: Lamp Disposal (for the US only)

 LAMP(S) INSIDE THIS PRODUCT CONTAIN MERCURY AND MUST BE RECYCLED OR DISPOSED OF ACCORDING TO LOCAL, STATE, OR FEDERAL LAWS. FOR MORE INFORMATION, GO TO WWW.DELL.COM/HG OR CONTACT THE ELECTRONIC INDUSTRIES ALLIANCE AT WWW.EIAE.ORG. FOR LAMP-SPECIFIC DISPOSAL INFORMATION, CHECK WWW.LAMPRECYCLE.ORG.

Specifications

Light Valve	0.95" 1080p DMD, DarkChip2™
Brightness	5000 ANSI Lumens (Max.)
Contrast Ratio	2500:1 (Natural) 10000:1 (Dynamic) 20000:1 (Static)
Uniformity	85% Typical (Japan Standard - JBMA)
Number of Pixels	1920 x 1080 (1080p)
Aspect Ratio	16:9
Displayable Color	1.07 billion colors (with Dithering)
Color Wheel Speed	2X
Projection Lens	F-Stop: F/2.6~2.9 Focal length, f=39.12~46.94 mm 1.2X manual Zoom Lens Throw ratio = 1.85~2.22 wide and tele Offset ratio: 115 ± 5%
Projection Screen Size	20.3~292.9 inches (diagonal)
Projection Distance	3.28~39.37 ft (1 m ~ 12 m)
Video Compatibility	Composite Video / S-Video: NTSC (J, M, 4.43), PAL (B, D, G, H, I, M, N, Nc, 60), SECAM (B, D, G, K, K1, L) HDMI, and Component Video input (via VGA and YPbPr RCA): 1080i/p, 720p, 576i/p, 480i/p
Power Supply	Universal AC 100-240 50-60 Hz with PFC input

Power Consumption

Normal mode: 525 W \pm 10% @ 110 Vac
Eco mode: 430 W \pm 10% @ 110 Vac
Power saving mode: <20 W (Wireless and Network On)
Standby mode: < 0.5 W (Network, VGA_Out, and Wireless Off)

Audio

2 speakers x 5 watt RMS

Noise Level

39 dB(A) Normal mode, 36 dB(A) Eco mode

Weight

16 lb (7.26 kg)

Dimensions (W x H x D)

17.01 x 5.31 x 11.42 inches (432 x 135 x 290 mm)

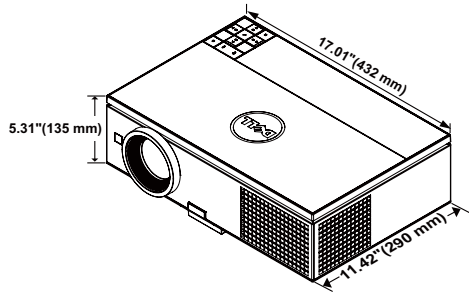

Environmental

Operating temperature: 5 °C - 35 °C (41 °F- 95 °F)
Humidity: 80 % maximum
Storage temperature: 0 °C to 60 °C (32 °F to 140 °F)
Humidity: 90 % maximum
Shipping temperature: -20 °C to 60 °C (-4 °F to 140 °F)
Humidity: 90 % maximum

I/O Connectors

Power: One AC power socket (3-pin - C14 inlet)
VGA input: Two 15-pin D-sub connectors (Blue), VGA-A and VGA-B, for analog RGB/Component input signals.
VGA output: One 15-pin D-sub connector (Black) for VGA-A loop through.
Component Video input: One set of RCA connector (RGB) for component input signal.

S-Video input: One standard 4-pin min-DIN S-Video connector for Y/C signal.

Composite Video input: One Yellow RCA jack for CVBS signal.

HDMI input: Two HDMI connector for supporting HDMI 1.3. HDCP compliant.

Analog Audio input: One 3.5 mm stereo mini phone jack (Blue).

Variable audio output: One 3.5 mm stereo mini phone jack (Green).

USB (type A) port: One USB connector for Photo/PtG viewer (JPG/PPT format).

USB (type B) port: One mini USB slave for remote support and One USB connector for supporting USB Display.

RS232 port: One 9-pin D-sub for RS232 communication.

RJ45 port: One RJ45 connector for control of projector through network and LAN Display.

12 V output: One 12 V DC / 200 mA max. relay output for driving automatic screen.

Wireless Dongle

Wireless Standard: IEEE802.11b/g/n

Wireless: One WiFi USB (type A) connector for supporting wireless dongle (USB interface, Optional).

OS environment: Windows 7/Vista/XP/2000, MAC OS X

Support: Presentation slides and projector control.

Allow connection up to 30 users at the same time.

4-to-1 split screen. Allow four presentation slides to be projected on screen.

Conference Control mode.

Supports Audio Projection (need to install extra driver)

Supports Video Streaming (up to 720p)

Lamp

Philips 400 W user-replaceable lamp (up to 2000 hours in eco mode; up to 1500 hours in normal mode)



NOTE: The lamp life rating for any projector is a measure of brightness degradation only, and is not a specification for the time it takes a lamp to fail and cease light output. Lamp life is defined as the time it takes for more than 50 percent of a lamp sample population to have brightness decrease by approximately 50 percent of the rated lumens for the specified lamp. The lamp life rating is not guaranteed in any way. The actual operating life span of a projector lamp will vary according to operating conditions and usage patterns. Usage of a projector in stressful conditions which may include dusty environments, under high temperatures, many hours per day, and abrupt powering-off will most likely result in a lamp's shortened operating life span or possible lamp failure.

RS232 Pin Assignment

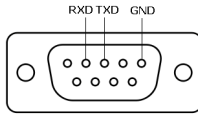

RS232 Protocol

- Communication Settings

Connection settings	Value
Baud Rate	19,200
Data Bits	8
Parity	None
Stop Bits	1

- **Command types**

To pop up the OSD menu and adjust the settings.

- **Control command Syntax (From PC to Projector)**

[H][AC][SoP][CRC][ID][SoM][COMMAND]

- **Example:** Power ON Command (Send low byte firstly)

--> 0xBE, 0xEF, 0x10, 0x05, 0x00, 0xC6, 0xFF, 0x11, 0x11, 0x01, 0x00, 0x01

- **Control Commands List**

To view the latest RS232 code, go to the Dell Support site at: support.dell.com.

PIP Combination Sources

	HDMI-A	HDMI-B	VGA-A	VGA-B	Component
HDMI-A	No	No	Yes	Yes	Yes
HDMI-B	No	No	Yes	Yes	Yes
VGA-A	Yes	Yes	No	No	No
VGA-B	Yes	Yes	No	No	No
Component	Yes	Yes	No	No	No
S-Video	Yes	Yes	No	No	No
Composite	Yes	Yes	No	No	No
Wireless Display	No	No	Yes	Yes	Yes
USB Display	No	No	Yes	Yes	Yes
USB Viewer	No	No	Yes	Yes	Yes

	S-Video	Composite	Wireless Display	USB Display	USB Viewer
HDMI-A	Yes	Yes	No	No	No
HDMI-B	Yes	Yes	No	No	No
VGA-A	No	No	Yes	Yes	Yes
VGA-B	No	No	Yes	Yes	Yes
Component	No	No	Yes	Yes	Yes
S-Video	No	No	Yes	Yes	Yes
Composite	No	No	Yes	Yes	Yes
Wireless Display	Yes	Yes	No	No	No
USB Display	Yes	Yes	No	No	No
USB Viewer	Yes	Yes	No	No	No

Compatibility Modes (Analog/Digital)

Resolution	Refresh Rate (Hz)	Hsync Frequency (KHz)	Pixel Clock (MHz)
640 x 350	70.087	31.469	25.175
640 x 480	59.940	31.469	25.175
640 x 480 p60	59.940	31.469	25.175
720 x 480 p60	59.940	31.469	27.000
720 x 576 p50	50.000	31.250	27.000
720 x 400	70.087	31.469	28.322
640 x 480	75.000	37.500	31.500
848 x 480	60.000	31.020	33.750
640 x 480	85.008	43.269	36.000
800 x 600	60.317	37.879	40.000
800 x 600	75.000	46.875	49.500
800 x 600	85.061	53.674	56.250
1024 x 768	60.004	48.363	65.000
1280 x 720 p50	50.000	37.500	74.250
1280 x 720 p60	60.000	45.000	74.250
1920 x 1080 i50	50.000	28.125	74.250
1920 x 1080 i60	60.000	33.750	74.250
1280 x 720	59.855	44.772	74.500
1024 x 768	75.029	60.023	78.750
1280 x 800	59.810	49.702	83.500
1366 x 768	59.790	47.712	85.500
1360 x 768	60.015	47.712	85.500
1024 x 768	84.997	68.677	94.500
1440 x 900	59.887	55.935	106.500
1152 x 864	75.000	67.500	108.000
1280 x 960	60.000	60.000	108.000
1280 x 1024	60.020	63.981	108.000
1152 x 864	85.000	77.095	119.651
1400 x 1050	59.978	65.317	121.750
1280 X 800	84.880	71.554	122.500
1280 x 1024	75.025	79.976	135.000
1440 X 900	74.984	70.635	136.750
1680 x 1050	59.954	65.290	146.250
1280 x 960	85.002	85.938	148.500
1920 x 1080	60.000	67.500	148.500
1400 X 1050	74.867	82.278	156.000
1280 x 1024	85.024	91.146	157.000
1440 X 900	84.842	80.430	157.000
1600 x 1200	60.000	75.000	162.000

Contacting Dell

For customers in the United States, call 800-WWW-DELL (800-999-3355).



NOTE: If you do not have an active Internet connection, you can find contact information on your purchase invoice, packing slip, bill, or Dell product catalog.

Dell™ provides several online and telephone-based support and service options. Availability varies by country and product, and some services may not be available in your area. To contact Dell for sales, technical support, or customer service issues:

- 1 Visit support.dell.com.
- 2 Verify your country or region in the **Choose A Country/Region** drop-down menu at the bottom of the page.
- 3 Click **Contact Us** on the left side of the page.
- 4 Select the appropriate service or support link based on your need.
- 5 Choose the method of contacting Dell that is convenient for you.

Appendix: Glossary

ANSI LUMENS — A standard for measuring the brightness. It is calculated by dividing a square meter image into nine equal rectangles, measuring the lux (or brightness) reading at the center of each rectangle, and averaging these nine points.

ASPECT RATIO — The most popular aspect ratio is 4:3 (4 by 3). Early television and computer video formats are in a 4:3 aspect ratio, which means that the width of the image is $\frac{4}{3}$ times the height.

Brightness — The amount of light emitted from a display or projection display or projection device. The brightness of projector is measured by ANSI lumens.

Color Temperature — The color appearance of white light. Low color temperature implies warmer (more yellow/red) light while high color temperature implies a colder (more blue) light. The standard unit for color temperature is Kelvin (K).

Component Video — A method of delivering quality video in a format that consists of the luminance signal and two separate chrominance signals and are defined as Y'Pb'Pr' for analog component and Y'Cb'Cr' for digital component. Component video is available on DVD players.

Composite Video — A video signal that combines the luma (brightness), chroma (color), burst (color reference), and sync (horizontal and vertical synchronizing signals) into a signal waveform carried on a single wire pair. There are three kinds of formats, namely, NTSC, PAL, and SECAM.

Compressed Resolution — If the input images are of higher resolution than the native resolution of the projector, the resulting image will be scaled to fit the native resolution of the projector. The nature of compression in a digital device means that some image content is lost.

Contrast Ratio — Range of light and dark values in a picture, or the ratio between their maximum and minimum values. There are two methods used by the projection industry to measure the ratio:

- 1 *Full On/Off* — measures the ratio of the light output of an all white image (full on) and the light output of an all black (full off) image.
- 2 *ANSI* — measures a pattern of 16 alternating black and white rectangles. The average light output from the white rectangles is divided by the average light output of the black rectangles to determine the ANSI contrast ratio.

Full On/Off contrast is always a larger number than ANSI contrast for the same projector.

dB — decibel — A unit used to express relative difference in power or intensity, usually between two acoustic or electric signals, equal to ten times the common logarithm of the ratio of the two levels.

Diagonal Screen — A method of measuring the size of a screen or a projected image. It measures from one corner to the opposite corner. A 9 ft high and 12 ft wide, screen has a diagonal of 15 ft. This document assumes that the diagonal dimensions are for the traditional 4:3 ratio of a computer image as per the example above.

DHCP — Dynamic Host Configuration Protocol — A network protocol that enables a server to automatically assign a TCP/IP address to a device.

DLP® — Digital Light Processing™ — Reflective display technology developed by Texas Instruments, using small manipulated mirrors. Light passing through a color filter is sent to the DLP mirrors which arrange the RGB colors into a picture projected onto screen, also known as DMD.

DMD — Digital Micro-Mirror Device — Each DMD consists of thousands of tilting, microscopic aluminum alloy mirrors mounted on a hidden yoke.

DNS — Domain Name System — An Internet service that translates domain names into IP addresses.

Focal Length — The distance from the surface of a lens to its focal point.

Frequency — It is the rate of repetition in cycles per seconds of electrical signals. Measured in Hz (Hertz).

HDCP — High-Bandwidth Digital-Content Protection — A specification developed by Intel™ Corporation to protect digital entertainment across digital interface, such as DVI, HDMI.

HDMI — High-Definition Multimedia Interface — HDMI carries both uncompressed high definition video along with digital audio and device control data in a single connector.

Hz (Hertz) — Unit of frequency.

IEEE802.11 — A set of standards for wireless local area network (WLAN) communication. 802.11b/g/n uses the 2.4 GHz band.

Keystone Correction — Device that will correct an image of the distortion (usually a wide-top narrow-bottom effect) of a projected image caused by improper projector to screen angle.

Maximum Distance — The distance from a screen the projector can be to cast an image that is usable (bright enough) in a fully darkened room.

Maximum Image Size — The largest image a projector can throw in a darkened room. This is usually limited by focal range of the optics.

Minimum Distance — The closest position that a projector can focus an image onto a screen.

NTSC — National Television Standards Committee. North American standard for video and broadcasting, with a video format of 525 lines at 30 frames per second.

PAL — Phase Alternating Line. A European broadcast standard for video and broadcasting, with a video format of 625 lines at 25 frames per second.

Reverse Image — Feature that allows you to flip the image horizontally. When used in a normal forward projection environment text, graphics, etc. are backwards. Reverse image is used for rear projection.

RGB — Red, Green, Blue — typically used to describe a monitor that requires separate signals for each of the three colors.

S-Video — A video transmission standard that uses a 4-pin mini-DIN connector to send video information on two signal wires called luminance (brightness, Y) and chrominance (color, C). S-Video is also referred to as Y/C.

SECAM — A French and international broadcast standard for video and broadcasting, closely related to PAL but with a different method of sending color information.

SSID — Service Set Identifiers — A name used to identify the particular wireless LAN to which a user wants to connect.

SVGA — Super Video Graphics Array — 800 x 600 pixels count.

SXGA — Super Extended Graphics Array, — 1280 x 1024 pixels count.

UXGA — Ultra Extended Graphics Array — 1600 x 1200 pixels count.

VGA — Video Graphics Array — 640 x 480 pixels count.

WEP — Wired Equivalent Privacy — This is a method for encrypting communication data. The encryption key is created and notified only to the communicating user, so the communication data cannot be decrypted by a third party.

XGA — Extended Video Graphics Array — 1024 x 768 pixels count.

WXGA — Wide Extended Graphics Array — 1280 x 800 pixels count.

1080p — 1080p is the shorthand identification for a set of HDTV high-definition video modes that are characterized by 1080 horizontal lines of resolution and progressive scan, meaning the image is not interlaced as is the case with the 1080i display standard.

Zoom Lens — Lens with a variable focal length that allows operator to move the view in or out making the image smaller or larger.

Zoom Lens Ratio — Is the ratio between the smallest and largest image a lens can

the project from a fixed distance. For example, a 1.4:1 zoom lens ratio means that a 10 foot image without zoom would be a 14 foot image with full zoom.

Index

A

- Adjusting the Projected Image 26
 - Elevator button 26
 - lower the projector
 - Elevator foot 26
 - Tilt adjustment wheel 26
 - Lowering the Projector Height 26
 - Raising the Projector Height 26
- Adjusting the Projector Zoom and Focus 27
 - Focus ring 27
 - Horizontal lens shift knob 27
 - Lens shift lock 27
 - Side door 27
 - Vertical lens shift knob 27
 - Zoom ring 27

C

- Changing the Lamp 106
- Connecting the Projector
 - 12 V DC Plug 23
 - 3 RCA to 3 RCA Component Video (Male to Male) cable 20
 - Composite Video cable 18
 - Connecting a Computer with a RS232 cable 14, 15
 - Connecting with a Component Cable 19

- Connecting with a Composite Cable 18
- Connecting with an HDMI Cable 21
- Connecting with an S-video Cable 17
- HDMI cable 21, 22
- Motorized projection screen 23
- Power cord 12, 13, 14, 15, 17, 18, 19, 20, 21, 22, 23, 24
- RS232 (9-pin D-sub female to female pin2-3 swap) cable 14, 24
- S-Video cable 17
- To Computer 12
- USB to USB cable 12
- USB-A to USB-B cable 15
- VGA to VGA cable 12, 13
- VGA to YPbPr cable 19

Connection Ports

- +12 V DC out connector 10
- Audio input connector 10
- Audio output connector 10
- Component Video input connector 10
- Composite Video connector 10
- HDMI-A connector 10
- HDMI-B connector 10
- Mini USB (Mini Type B) connector for remote control 10
- Power cord connector 10

- RJ45 connector 10
- RS232 (D-sub) connector 10
- Security cable slot 10
- S-Video connector 10
- USB Type A connector for USB Viewer 10
- USB Type B connector for USB Display 10
- VGA-A input (D-sub) connector 10
- VGA-A output (monitor loop-through) connector 10
- VGA-B input (D-sub) connector 10
- WiFi USB (Type A) connector 10

Contact Dell 7, 104, 106

Control Panel 30

D

Dell

- contacting 115

M

Main Unit 8

- Control panel 8

- Elevator button for height adjustments 8

- Focus tab 8

- IR receivers 8

- Lens 8

- Lens cap 8

O

On-Screen Display 37

- ADVANCED SETTINGS 40

- AUDIO INPUT 40

- AUTO ADJUST 38

- BRIGHTNESS/CONTRAST 39

- HELP 54

- INPUT SOURCE 37

- INPUT SOURCE MULTIPLE DISPLAY 38

- LANGUAGE 54

- VIDEO MODE 39

- VOLUME 40

P

phone numbers 115

Powering On/Off the Projector

- Powering Off the Projector 25

- Powering On the Projector 25

R

Remote Control 32

- IR receiver 31

S

Specifications

- Audio 109

- Brightness 108

- Color Wheel Speed 108

- Contrast Ratio 108

- Dimensions 109

- Displayable Color 108

- Environmental 109
- I/O Connectors 109
- Light Valve 108
- Noise Level 109
- Number of Pixels 108
- Power Consumption 109
- Power Supply 108
- Projection Distance 108
- Projection Lens 108
- Projection Screen Size 108
- RS232 Protocol 112
- Uniformity 108
- Video Compatibility 108
- Weight 109

support

- contacting Dell 115

T

telephone numbers 115

Troubleshooting 101

- Contact Dell 101